

ON THE PROBABILITY THAT SELF-AVOIDING WALK ENDS AT A GIVEN POINT

HUGO DUMINIL-COPIN, ALEXANDER GLAZMAN, ALAN HAMMOND
AND IOAN MANOLESCU

ABSTRACT. We prove two results on the delocalization of the endpoint of a uniform self-avoiding walk on \mathbb{Z}^d for $d \geq 2$. We show that the probability that a walk of length n ends at a point x tends to 0 as n tends to infinity, uniformly in x . Also, for any fixed $x \in \mathbb{Z}^d$, this probability decreases faster than $n^{-1/4+\varepsilon}$ for any $\varepsilon > 0$. When $\|x\| = 1$, we thus obtain a bound on the probability that self-avoiding walk is a polygon.

1. INTRODUCTION

Flory and Orr [9, 20] introduced self-avoiding walk as a model of a long chain of molecules. Despite the simplicity of its definition, the model has proved resilient to rigorous analysis. While in dimensions $d \geq 5$ lace expansion techniques provide a detailed understanding of the model, and the case $d = 4$ is the subject of extensive ongoing research, very little is known for dimensions two and three.

The present paper uses combinatorial techniques to prove two intuitive results for dimensions $d \geq 2$. We feel that the interest of the paper lies not only in its results, but also in techniques employed in the proofs. To this end, certain tools are emphasised as they may be helpful in future works as well.

We mention two results from the early 1960s that stand at the base of our arguments: Kesten's *pattern theorem*, which concerns the local geometry of a typical self-avoiding walk, and Hammersley and Welsh's *unfolding argument*, which gives a bound on the correction to the exponential growth rate in the number of such walks.

1.1. The model. Let $d \geq 2$. For $u \in \mathbb{R}^d$, let $\|u\|$ denote the Euclidean norm of u . Let $E(\mathbb{Z}^d)$ denote the set of nearest-neighbour bonds of the integer lattice \mathbb{Z}^d . A *walk* of length $n \in \mathbb{N}$ is a map $\gamma : \{0, \dots, n\} \rightarrow \mathbb{Z}^d$ such that $(\gamma_i, \gamma_{i+1}) \in E(\mathbb{Z}^d)$ for each $i \in \{0, \dots, n-1\}$. An injective walk is called *self-avoiding*. Let SAW_n denote the set of self-avoiding walks of length n that start at 0. We denote by $\mathbb{P}_{\text{SAW}_n}$ the uniform law on SAW_n , and by $\mathbb{E}_{\text{SAW}_n}$ the associated expectation. The walk under the law $\mathbb{P}_{\text{SAW}_n}$ will be denoted by Γ .

2010 Mathematics Subject Classification. Primary: 60K35. Secondary: 60D05.

1.2. The endpoint displacement of self-avoiding walk. The law of the endpoint displacement under $\mathbb{P}_{\text{SAW}_n}$ is a natural object of study in an inquiry into the global geometry of self-avoiding walk. The displacement is quantified by the Flory exponent ν , specified by the conjectural relation $\mathbb{E}_{\text{SAW}_n}[|\Gamma_n|^2] = n^{2\nu+o(1)}$.

In dimension $d \geq 5$, it is rigorously known that $\nu = 1/2$ (see Hara and Slade [12, 13]). When $d = 4$, $\nu = 1/2$ is also anticipated, though this case is more subtle from a rigorous standpoint. Recently, some impressive results have been achieved using a supersymmetric renormalization group approach for continuous-time weakly self-avoiding walk: see [1, 3, 4] and references therein.

When $d = 2$, $\nu = 3/4$ was predicted nonrigorously in [18, 19] using the Coulomb gas formalism, and then in [7, 8] using Conformal Field Theory. It is also known subject to the assumption of existence of the scaling limit and its conformal invariance [15]. Unconditional rigorous statements concerning the global geometry of the model are almost absent in the low dimensional cases at present. In [5], sub-ballistic behaviour of self-avoiding walk in all dimensions $d \geq 2$ was proved, in a step towards the assertion that $\nu < 1$.

1.3. Results. This paper is concerned in part with ruling out another extreme behaviour for endpoint displacement, namely that Γ_n is close to the origin. In [17], the mean-square displacement of the walk is proved to exceed $n^{4/(3d)}$. As we will shortly explain, a variation of that argument shows that $\mathbb{P}_{\text{SAW}_n}(|\Gamma_n| = 1) \leq \frac{2}{3}$ for all n high enough. Recently, Itai Benjamini posed the question of strengthening this conclusion to $\mathbb{P}_{\text{SAW}_n}(|\Gamma_n| = 1) \rightarrow 0$ as $n \rightarrow \infty$. In this article, we confirm this assertion and prove uniform delocalization for Γ_n .

Theorem 1.1. *Let $d \geq 2$. As $n \rightarrow \infty$, $\sup_{x \in \mathbb{Z}^d} \mathbb{P}_{\text{SAW}_n}(\Gamma_n = x) \rightarrow 0$.*

In a separate investigation, we give a bound on the rate of convergence.

Theorem 1.2. *Let $d \geq 2$. For each $\varepsilon > 0$ and $x \in \mathbb{Z}^d$, there exists $n_0 = n_0(x, \varepsilon)$ such that, for $n \geq n_0$, $\mathbb{P}_{\text{SAW}_n}(\Gamma_n = x) \leq n^{-1/4+\varepsilon}$.*

Note that neither theorem implies the other.

Our quantitative answer to Benjamini's question – informally, an upper bound on the probability that a self-avoiding walk is a polygon – is given by taking $\|x\| = 1$ in the second theorem. This case will be explicitly addressed in Theorem 5.1. We mention that, in the case of \mathbb{Z}^2 , the conjecture $\mathbb{P}_{\text{SAW}_{2n+1}}(|\Gamma| = 1) = n^{-59/32+o(1)}$ follows from well-known predictions. (Naturally, a walk of even length may not end one step from the origin.) Indeed, this probability equals np_n/c_n , where p_n and c_n denote the number of length n self-avoiding polygons and self-avoiding walks (such polygons will be formally introduced in Section 5, and are considered up to translations). The

two relevant predictions are $p_n = n^{-5/2+o(1)}\mu_c^n$ and $c_n = n^{11/32+o(1)}\mu_c^n$, where $\mu_c = \lim_n |c_n|^{1/n}$ is the connective constant. The first of these may be derived from a conjectural hyperscaling relation [16, 1.4.14] linking its value to that of the Flory exponent ν ; the second was first predicted by Nienhuis in [18]; for relations to $\text{SLE}_{8/3}$, see Prediction 5 in [15].

The rest of the paper is structured as follows. In Section 2, we lay out some of the tools used in the proofs, namely the multi-valued map principle, unfolding arguments and the Hammersley-Welsh bound. The proofs of Theorems 1.1 and 1.2 may be found in Sections 4 and 5. In spite of the similarity of the results, the two proofs employ very different techniques, and indeed Sections 4 and 5 may be read independently of each other.

In Section 3 we define and discuss notions revolving around Kesten's pattern theorem. Although the material in this section is not original *per se*, our presentation is novel and, we hope, fruitful for further research. An example of a consequence is the following delocalization of the midpoint of self-avoiding walk.

Proposition 1.3. *There exists a constant $C > 0$ such that, for $n \in \mathbb{N}$,*

$$\sup_{x \in \mathbb{Z}^d} \mathbb{P}_{\text{SAW}_n} \left(\Gamma_{\lfloor \frac{n}{2} \rfloor} = x \right) \leq Cn^{-\frac{1}{2}}.$$

A comment on notation. The only paths which we consider in this paper are self-avoiding walks. Thus, we may, and usually will, omit the term “self-avoiding” in referring to them. In the course of the paper, several special types of walk will be considered – such as self-avoiding bridges and self-avoiding half-space walks – and this convention applies to these objects as well.

Acknowledgments. We thank Itai Benjamini for suggesting the problem to us. The first, second and fourth authors were supported by the ERC grant AG CONFRA as well as the FNS. The third author was supported by EPSRC grant EP/I004378/1 and thanks the Mathematics Department of the University of Geneva for its hospitality during the year 2012–13.

2. PRELIMINARIES

2.1. General notation. We denote by $\langle \cdot | \cdot \rangle$ the scalar product on \mathbb{R}^d , and recall the notation $\|\cdot\|$ for the Euclidean norm on this space. Let e_1, \dots, e_d be the natural basis of \mathbb{Z}^d . We will consider e_1 to be the *vertical* direction. The cardinality of a set E will be denoted by $|E|$. The length of a walk γ , being the cardinality of its edge-set, will be denoted by $|\gamma|$. For $0 \leq i \leq j \leq n$, we write $\gamma[i, j] = (\gamma_i, \dots, \gamma_j)$.

For $m, n \in \mathbb{N}$, let γ and $\tilde{\gamma}$ be two walks of lengths m and n , respectively, neither of which needs to start at 0. The concatenation $\gamma \circ \tilde{\gamma}$ of γ and $\tilde{\gamma}$ is

given by

$$(\gamma \circ \tilde{\gamma})_k = \begin{cases} \gamma_k & k \leq m, \\ \gamma_m + (\tilde{\gamma}_{k-m} - \tilde{\gamma}_0) & m+1 \leq k \leq m+n. \end{cases}$$

2.2. The multi-valued map principle. Multi-valued maps and the multi-valued map principle stated next will play a central role in our analysis.

A multivalued map from a set A to a set B is a map $\Phi : A \rightarrow \mathfrak{P}(B)$. For $b \in B$, let $\Phi^{-1}(b) = \{a \in A : b \in \Phi(a)\}$ and

$$(2.1) \quad \Lambda_\Phi(b) = \sum_{a \in \Phi^{-1}(b)} \frac{1}{|\Phi(a)|}.$$

The quantity $\Lambda_\Phi(b)$ may be viewed as a (local) contracting factor of the map, as illustrated by the following statement.

Lemma 2.1 (Multi-valued map principle). *Let A and B be two finite sets and $\Phi : A \rightarrow \mathfrak{P}(B)$ be a multi-valued map. Then*

$$|A| = \sum_{b \in B} \Lambda_\Phi(b) \leq |B| \max_{b \in B} \Lambda_\Phi(b).$$

The proof is immediate. We will often apply the lemma in the special situation where, for any $b \in B$, $|\Phi(a)|$ is independent of $a \in \Phi^{-1}(b)$. Then the contracting factor may be written $\Lambda_\Phi(b) = \frac{|\Phi^{-1}(b)|}{|\Phi(a)|}$ for any $a \in \Phi^{-1}(b)$.

2.3. Unfolding self-avoiding walks. An unfolding operation, similar to the one used in [11] and more recently in [17], will be applied on several occasions. We first describe the operation in its simplest form, and then the specific version that we will use.

For $z \in \mathbb{Z}^d$, let \mathcal{R}_z be the orthogonal reflection with respect to the plane $\{x \in \mathbb{Z}^d : \langle x | e_1 \rangle = \langle z | e_1 \rangle\}$, i.e. the map such that for any $x \in \mathbb{Z}^d$,

$$\mathcal{R}_z(x) = x + 2\langle z - x | e_1 \rangle e_1.$$

For $\gamma \in \text{SAW}_n$, let k be any index such that

$$\langle \gamma_k | e_1 \rangle = \max\{\langle \gamma_j | e_1 \rangle : 0 \leq j \leq n\}.$$

The simplest unfoldings of γ are those walks obtained by concatenating $\gamma[0, k]$ and $\mathcal{R}_{\gamma_k}(\gamma[k, n])$ for such an index k . The condition on k ensures that any such walk is indeed self-avoiding.

Of the numerous choices of the unfolding point index k , the following seems to be the most suitable for our purpose.

Definition 2.2. *For $\gamma \in \text{SAW}_n$, the hanging time $\text{hang} = \text{hang}(\gamma)$ is the index $k \in \{0, \dots, n\}$ for which γ_k is maximal for the lexicographical order of \mathbb{Z}^d . We call γ_{hang} the hanging point and write $\gamma^1 = \gamma[0, \text{hang}]$ and $\gamma^2 = \gamma[\text{hang}, n]$.*

Here are two essential properties of the hanging point. First, γ_{hang} depends only on the set of points visited by γ , not on the order in which they are visited. Second, the lexicographical order of \mathbb{Z}^d is invariant under translations; thus the hanging time of γ is the same as that of any translate of γ .

In a variation (motivated by technical considerations) of the unfolding procedure, we will sometimes add a short walk between $\gamma[0, k]$ and $\mathcal{R}_{\gamma_k}\gamma[k, n]$. The specific unfolding that we will use is defined next.

Definition 2.3. *For a walk $\gamma \in \text{SAW}_n$, define $\text{Unf}(\gamma) \in \text{SAW}_{n+1}$ to be the concatenation of γ^1 , the walk across the edge e_1 , and the translation of $\mathcal{R}_{\gamma_{\text{hang}}}\gamma^2$ by e_1 .*

In [17], Madras used an unfolding argument to obtain a lower bound on the mean-square displacement of a uniform self-avoiding walk. A simple adaptation of his technique proves that $\mathbb{P}_{\text{SAW}_n}(\|\Gamma_n\| = 1) \leq \frac{2}{3}$ for all $n \geq 3^d + 1$. We now sketch this argument since, for example, the proof of Theorem 1.2 in Section 5 may be viewed as an elaboration.

To any walk $\gamma \in \text{SAW}_n$ with $\|\gamma_n\| = 1$, choose an axial direction in which γ has maximal coordinate at least two – we will assume this to be the e_1 -direction – and associate to γ its simple unfolding $b \in \text{SAW}_n$, given by concatenating the e_1 -reflection of γ^2 to γ^1 . Any unfolded walk b corresponds to at most two walks γ with $\|\gamma_n\| = 1$. This is because the level at which the unfolding was done is one among $\frac{\langle b_n | e_1 \rangle - 1}{2}$, $\frac{\langle b_n | e_1 \rangle}{2}$ and $\frac{\langle b_n | e_1 \rangle + 1}{2}$, of which at most two are integers.

Moreover, since the maximal e_1 -coordinate of γ is at least two, the unfolding of γ is such that $\|b_n\| > 1$. The choice of axial direction for reflection may be made in such a way that it may be determined from the unfolded walk. Thus, $\mathbb{P}_{\text{SAW}_n}(\|\Gamma_n\| = 1) \leq \frac{2}{3}$.

2.4. The Hammersley-Welsh bound. For $n \in \mathbb{N}$, let $c_n = |\text{SAW}_n|$ denote the number of length- n walks that start at the origin. Write $\mu_c \in (0, \infty)$ for the connective constant, given by $\mu_c = \lim_n c_n^{1/n}$. Its existence follows from the submultiplicativity inequality $c_{n+m} \leq c_n c_m$ and Fekete's lemma. Furthermore, the limit defining μ_c is decreasing, thus providing a lower bound on c_n .

The value of μ_c is not rigorously known for any lattice \mathbb{Z}^d with $d \geq 2$. The only non-trivial lattice for which the connective constant (for unweighted self-avoiding walks) has been rigorously derived is the hexagonal lattice, see [6], using parafermionic observables (also see [2, 10] for other applications of parafermionic observables, including the computation of the connective constant for a model of weighted walks).

An upper bound for the growth rate of c_n is provided by the Hammersley-Welsh argument of [11] (which is proved by an iterative unfolding procedure).

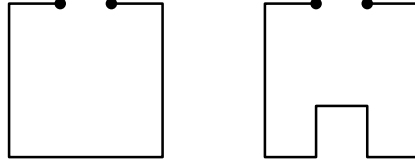

FIGURE 1. An example of type I and II patterns for $d = 2$.

It states the existence of a constant $c_{HW} > 0$ such that, for all $n \in \mathbb{N}$,

$$(2.2) \quad \mu_c^n \leq c_n \leq e^{c_{HW}\sqrt{n}} \mu_c^n.$$

3. THE SHELL OF A WALK: DEFINITION AND APPLICATIONS

The shell of a walk, defined next, is a notion that appeared implicitly in Kesten's proof of the pattern theorem in [14]. In the next subsections, we present two consequences of the pattern theorem which may be of some general use. We illustrate this by the proof of Proposition 1.3.

Definition 3.1 (Type I/II patterns). *Type I and II patterns are self-avoiding walks χ^I , respectively χ^{II} , contained in the cube $[0, 3]^d$, with the properties that*

- χ^I and χ^{II} both visit all vertices of the boundary of $[0, 3]^d$,
- χ^I and χ^{II} both start at $(3, 1, \dots, 1)$ and end at $(3, 2, 1, \dots, 1)$,
- $|\chi^{II}| = |\chi^I| + 2$.

Figure 1 contains examples of such patterns for $d = 2$. The existence of such pairs of walks for any dimension $d \geq 2$ may be easily checked, and no details are given here. Fix a pair of type I and II patterns for the rest of the paper.

A pattern χ is said to occur at step k of a walk γ if $\gamma[k, k + |\chi|]$ is a translate of χ . A walk may have several occurrences of both type I and II patterns. Note that occurrences of such patterns are necessarily disjoint.

Definition 3.2 (Shell of a walk). *Two self-avoiding walks are equivalent if one can be obtained from the other by changing some type I patterns into type II patterns and some type II patterns into type I patterns. Classes for this equivalence relation are called shells.*

A shell may be viewed as a walk with certain slots where type I and II patterns may be inserted. Note that a shell may contain walks of different lengths. Shells are convenient to work with as many interesting events may be written in terms of the shell of the walk (see below for examples of such events).

The shell of the walk γ is denoted $\varsigma(\gamma)$; $T_I(\gamma)$ and $T_{II}(\gamma)$ denote the number of occurrences for patterns of type I and II in γ . Observe that $T_I(\gamma)$ and

$T_{II}(\gamma)$ are determined by $\varsigma(\gamma)$ and the length of γ . When the random variable Γ is involved, we will sometimes drop the explicit dependence of T on Γ .

By Kesten's pattern theorem [14, Thm. 1], there exist constants $c > 0$ and $\delta > 0$ such that, for any $n \geq d3^d$,

$$(3.1) \quad \mathbb{P}_{\text{SAW}_n}(T_I(\Gamma) \leq \delta n) \leq e^{-cn} \quad \text{and} \quad \mathbb{P}_{\text{SAW}_n}(T_{II}(\Gamma) \leq \delta n) \leq e^{-cn}.$$

3.1. Shell probabilities are stable under perturbation of walk length.

The following lemma states that, when considering typical events expressed only in terms of shells, their $\mathbb{P}_{\text{SAW}_n}$ and $\mathbb{P}_{\text{SAW}_{n+2k}}$ probabilities are comparable for k small enough. The lemma will be instrumental when applying multi-valued map arguments.

Let A be a subset of shells and let

$$A_n = \{\gamma \in \text{SAW}_n : \varsigma(\gamma) \in A\}.$$

The set A may be chosen as, for example, the set of half-space walks, bridges, irreducible bridges, walks with a certain number of renewal times or walks with very large quasi-loops. This flexibility in the choice of A may render the lemma useful in a broad context. We will use it in the proof of Theorem 1.1, more precisely in Proposition 4.2.

Lemma 3.3. *For any $c > 0$, there exists $C > 0$ such that the following occurs. Let A be a set of shells and n be an integer such that $|A_n| \geq e^{-c\sqrt{n}}\mu_c^n$. Then, for any $0 \leq k \leq n^{1/5}$,*

$$(3.2) \quad |A_{n-2k}| \geq C|A_n|\mu_c^{-2k}.$$

The argument by which we will derive the lemma is a direct adaptation of one in [14], where the claim is proved for $A_n = \text{SAW}_n$. In this case, the result can be improved to $|k| \leq n^{1/3}$ due to the submultiplicativity property of the number of self-avoiding walks. For the uses we have in mind, $n^{1/5}$ is sufficient.

Proof. Fix $c > 0$. It suffices to prove the statement for n large enough (the specific requirements on n will be indicated in the proof). Fix a value n .

Let $\delta, c_\delta > 0$ be constants such that (3.1) holds. Define

$$\begin{aligned} \tilde{A}_m &= \{\gamma \in A_m : T_{II}(\gamma) > \delta n\}, \\ \tilde{A}_{m+2} &= \{\gamma \in A_{m+2} : T_{II}(\gamma) > \delta n + 1\}, \\ \tilde{A}_{m+4} &= \{\gamma \in A_{m+4} : T_{II}(\gamma) > \delta n + 2\}. \end{aligned}$$

Note that the assumption $|A_n| \geq e^{-c\sqrt{n}}\mu_c^n$ and the choice of δ yield

$$|A_n \setminus \tilde{A}_n| \leq e^{-c_\delta n} |\text{SAW}_n| \leq e^{-c_\delta n} e^{(c_{HW}+c)\sqrt{n}} |A_n|.$$

As a consequence, for n larger than some value depending on c_δ, c_{HW} and c ,

$$(3.3) \quad |\tilde{A}_n| \geq \frac{1}{2}|A_n| \geq \frac{1}{2}e^{-c\sqrt{n}}\mu_c^n.$$

This will be useful later, and henceforth we assume that n is sufficiently large for (3.3) to hold. Let us also assume that $\delta n \geq n^{3/4}$.

We start by proving that, for any $\ell \in \mathbb{N}$ with $|\ell| \leq n^{3/4}$, when setting $m = n + 2\ell$,

$$(3.4) \quad \frac{|\tilde{A}_{m+2}|}{|\tilde{A}_m|} - \frac{|\tilde{A}_{m+4}|}{|\tilde{A}_{m+2}|} \leq \frac{2}{\delta^3 n} \cdot \frac{|\tilde{A}_m|}{|\tilde{A}_{m+2}|}.$$

Consider the multi-valued map from \tilde{A}_{m+2} into \tilde{A}_m that consists of replacing a type II pattern by a type I pattern. The multi-valued map principle implies

$$(3.5) \quad |\tilde{A}_{m+2}| = \sum_{\gamma \in \tilde{A}_m} \frac{T_I(\gamma)}{T_{II}(\gamma) + 1}.$$

Similarly, by considering the multi-valued map from \tilde{A}_{m+4} into \tilde{A}_m that replaces two type II patterns by type I patterns, one obtains

$$|\tilde{A}_{m+4}| = \sum_{\gamma \in \tilde{A}_m} \frac{T_I(\gamma)(T_I(\gamma) - 1)}{(T_{II}(\gamma) + 1)(T_{II}(\gamma) + 2)}.$$

It follows that

$$\begin{aligned} & \frac{|\tilde{A}_{m+2}|^2}{|\tilde{A}_m|} - |\tilde{A}_{m+4}| \\ &= \left(\sum_{\gamma \in \tilde{A}_m} 1 \right)^{-1} \left(\sum_{\gamma \in \tilde{A}_m} \frac{T_I(\gamma)}{T_{II}(\gamma) + 1} \right)^2 - \sum_{\gamma \in \tilde{A}_m} \frac{T_I(\gamma)(T_I(\gamma) - 1)}{(T_{II}(\gamma) + 1)(T_{II}(\gamma) + 2)} \\ &\leq \sum_{\gamma \in \tilde{A}_m} \left(\left(\frac{T_I(\gamma)}{T_{II}(\gamma) + 1} \right)^2 - \frac{T_I(\gamma)(T_I(\gamma) - 1)}{(T_{II}(\gamma) + 1)(T_{II}(\gamma) + 2)} \right) \leq \frac{2}{\delta^3 n} |\tilde{A}_m|. \end{aligned}$$

The first inequality is due to Cauchy-Schwarz and the second, valid when n is high enough, to $T_{II}(\gamma) \geq \delta n$ and $T_I(\gamma) \leq m \leq n + 2n^{3/4}$. Dividing the above by $|\tilde{A}_{m+2}|$ yields (3.4).

Let us now show that

$$(3.6) \quad \frac{|\tilde{A}_{n-2k+2}|}{|\tilde{A}_{n-2k}|} < \mu_c^2 + \frac{1}{n^{1/5}}, \quad \text{for all } 0 \leq k \leq n^{1/5}.$$

Assume instead that for some $0 \leq k \leq n^{1/5}$ and $m = n - 2k$,

$$\frac{|\tilde{A}_{m+2}|}{|\tilde{A}_m|} \geq \mu_c^2 + \frac{1}{n^{1/5}}.$$

In particular, this implies that $\frac{|\tilde{A}_m|}{|A_{m+2}|} \leq 1$. Using (3.4), it may be shown by recurrence that, for n large enough and $\ell \leq n^{3/4} + k$, we have $\frac{|\tilde{A}_{m+2\ell}|}{|A_{m+2\ell+2}|} \leq 1$ and

$$\frac{|\tilde{A}_{m+2\ell+2}|}{|\tilde{A}_{m+2\ell}|} \geq \mu_c^2 + \frac{1}{n^{1/5}} - \frac{2}{\delta^3 n} \sum_{k=1}^{\ell} \frac{|\tilde{A}_{m+2k-2}|}{|\tilde{A}_{m+2k}|} \geq \mu_c^2 + \frac{1}{2n^{1/5}}.$$

Thus,

$$\begin{aligned} |\tilde{A}_{n+2n^{3/4}}| &\geq |\tilde{A}_n| \left(\mu_c^2 + \frac{1}{2n^{1/5}} \right)^{n^{3/4}} \\ &\geq \frac{1}{2} e^{-c\sqrt{n}} \mu_c^n \left(\mu_c^2 + \frac{1}{2n^{1/5}} \right)^{n^{3/4}} \\ &> e^{c_{HW} \sqrt{n+2n^{3/4}}} \mu_c^{n+2n^{3/4}}. \end{aligned}$$

In the second inequality, we used (3.3), and, in the third, we assumed that n exceeds an integer that is determined by c , c_{HW} and μ_c . The above contradicts the Hammersley-Welsh bound (2.2), and (3.6) is proved.

We conclude by observing that (3.6) and (3.3) imply that, for all $k \leq n^{1/5}$,

$$\frac{1}{2}|A_n| \leq |\tilde{A}_n| \leq \left(\mu_c^2 + \frac{1}{n^{1/5}} \right)^k |\tilde{A}_{n-2k}| \leq C \mu_c^{2k} |\tilde{A}_{n-2k}| \leq C \mu_c^{2k} |A_{n-2k}|,$$

where C is some constant depending only on μ_c . \square

Remark 3.4. *If one assumes that $|A_m| \geq e^{-c\sqrt{m}} \mu_c^m$ for any $m \in [n - n^{3/4}, n + n^{3/4}]$, then the same technique implies a stronger result. In addition to (3.6), a converse inequality may be obtained by a similar argument. Assuming $|A_{m+2}|/|A_m| \leq \mu_c^2 - \frac{1}{n^{1/5}}$ for some $m \in [n - 2n^{1/5}, n + 2n^{1/5}]$ leads to a contradiction by going backward instead of forward. It follows that there exists a constant $C > 0$ such that the ratio $\mu_c^{2k}|A_n|/|A_{n+2k}|$ is contained between $1/C$ and C for all $|k| \leq n^{1/5}$. We expect that in most applications, the important bound will be the one given by Lemma 3.3.*

3.2. Redistribution of patterns. We present a technical result, Lemma 3.5, concerning the distribution of patterns of type I and II within a given typical shell. Roughly speaking, when considering walks of a given length with a given shell, there is a specified number of type I patterns to be allocated into the available slots, and this allocation occurs uniformly. For a typical shell, the number of slots, and the number of type I patterns to be allocated into them, are macroscopic quantities, of the order of the walk's length. Thus,

conditionally on a typical shell, the number of type I patterns in a macroscopic part of the walk has a Gaussian behaviour, with variance of the order of the walk's length.

Lemma 3.5 will prove to be very useful: after its proof, we will derive Proposition 1.3, our result concerning midpoint delocalization, as a corollary. The lemma will also play an important role in our quantitative study of endpoint delocalization in Section 5.

Consider a shell σ and (S_1, S_2) a partition of its slots. For a walk $\gamma \in \sigma$ and $i = 1, 2$, let $T_I^i(\gamma)$ (and $T_{II}^i(\gamma)$) be the number of type I (and type II) patterns in S_i . With this notation, $T_I = T_I^1 + T_I^2$ and $T_{II} = T_{II}^1 + T_{II}^2$.

Lemma 3.5. *Let $\delta, \varepsilon, \varepsilon', C > 0$. There exists $N > 0$ such that the following occurs. Let $n \geq N$, σ be a shell and (S_1, S_2) be a partition of its slots with $|S_1|, |S_2| \geq \delta n$. Suppose that n and σ are such that T_I and T_{II} are both larger than δn (and recall that T_I and T_{II} are determined by n and σ). Then,*

$$(3.7) \quad \mathbb{P}_{\text{SAW}_n} \left(\left| T_I^1(\Gamma) - \frac{T_I |S_1|}{|S_1| + |S_2|} \right| \geq \sqrt{n} (\log n)^{1/2 + \varepsilon} \mid \varsigma(\Gamma) = \sigma \right) \leq \frac{1}{n^C}.$$

Moreover, if k_1, k_2 are such that $\left| k_i - \frac{T_I |S_1|}{|S_1| + |S_2|} \right| \leq 2\sqrt{n} (\log n)^{1/2 + \varepsilon}$ and $|k_1 - k_2| \leq \sqrt{n}$, then

$$(3.8) \quad \frac{\mathbb{P}_{\text{SAW}_n}(T_I^1(\Gamma) = k_1 \mid \varsigma(\Gamma) = \sigma)}{\mathbb{P}_{\text{SAW}_n}(T_I^1(\Gamma) = k_2 \mid \varsigma(\Gamma) = \sigma)} \geq n^{-\varepsilon'}.$$

Before the technical proof, we give a heuristic explanation. For simplicity, suppose that S_1 comprises the first K slots of σ , and S_2 the remainder.

Consider the random process $W : \{0, \dots, T_I + T_{II}\} \rightarrow \{0, \dots, T_I\}$ whose value at $0 \leq k \leq T_I + T_{II}$ is the number of type I patterns allocated into the first k slots of σ . Under $\mathbb{P}_{\text{SAW}_n}(\cdot \mid \varsigma(\Gamma) = \sigma)$, W is uniform in the set of trajectories of length $T_I + T_{II}$, with steps 0 or 1, starting at 0 and ending at T_I .

In other words, consider the random walk with increments zero with probability $\frac{T_{II}}{T_I + T_{II}}$ and one with probability $\frac{T_I}{T_I + T_{II}}$. Then W has the law of this walk, conditioned on arriving at T_I at time $T_I + T_{II}$. The assumptions on T_I and T_{II} ensure that the variance of the increment of W is bounded away from 0.

With this notation $T_I^1 = W_K$. The inequalities for $|S_1|$ and $|S_2|$ ensure that the point K is not too close to the endpoints of the range of W . It follows from standard estimates on random walk bridges that $\frac{T_I^1}{\sqrt{T_I + T_{II}}}$ follows an approximately Gaussian distribution. If this approximation is used, then Lemma 3.5 follows by basic computations. Also, the probability that W_K equals ℓ is at most $Cn^{-1/2}$ for some constant $C > 0$ and any $\ell \in \mathbb{Z}$. This last observation will be used in the proof of Proposition 1.3.

Proof of Lemma 3.5. Fix $\delta, \varepsilon, \varepsilon'$ and C strictly positive. Let n, σ and (S_1, S_2) be as in the lemma. The parameter n will be assumed to be large in the sense that $n \geq N$ for some $N = N(\delta, \varepsilon, \varepsilon', C)$.

If Γ is distributed according to $\mathbb{P}_{\text{SAW}_n}(\cdot | \zeta(\gamma) = \sigma)$, then the T_I type I patterns and T_{II} type II patterns are distributed uniformly in the slots of σ . Thus, for $k \in \{0, \dots, |S_1|\}$,

$$(3.9) \quad \mathbb{P}_{\text{SAW}_n}(T_I^1(\Gamma) = k | \zeta(\Gamma) = \sigma) = \frac{\binom{|S_1|}{k} \binom{|S_2|}{T_I - k}}{\binom{|S_1| + |S_2|}{T_I}}.$$

Write $m = |S_1| + |S_2|$, $|S_1| = \alpha m$ and $T_I = \beta m$. By assumption $\alpha, \beta \in [\delta, 1 - \delta]$ and $m \geq 2\delta n$. Let $Z = \frac{T_I}{\alpha\beta m} - 1$. Under $\mathbb{P}_{\text{SAW}_n}(\cdot | \zeta(\Gamma) = \sigma)$, Z is a random variable of mean 0, such that $\alpha\beta(1 + Z)m \in \mathbb{Z} \cap [0, \min\{|S_1|, T_I\}]$.

First, we investigate the case where Z is close to its mean, corresponding to the second part of the lemma. By means of a computation which uses Stirling's approximation and the explicit formula (3.9), we find that

$$(3.10) \quad \mathbb{P}_{\text{SAW}_n}(Z = z | \zeta(\Gamma) = \sigma) = (1 + o(1)) \frac{\exp\left(-\frac{\alpha\beta}{2(1-\alpha)(1-\beta)} m z^2\right)}{\sqrt{2\pi\alpha\beta(1-\alpha)(1-\beta)m}},$$

where $o(1)$ designates a quantity tending to 0 as n tends to infinity, uniformly in the acceptable choices of σ, S_1, S_2 and z , with $|z| \leq \frac{2\sqrt{n}(\log n)^{1/2+\varepsilon}}{\alpha\beta m}$.

Consider now k_1, k_2 be as in the second part of the lemma. Define the corresponding $z_i = \frac{k_i}{\alpha\beta m} - 1$, and note that $|z_i| \leq \frac{2\sqrt{n}(\log n)^{1/2+\varepsilon}}{\alpha\beta m}$ and $|z_1 - z_2| \leq \frac{\sqrt{n}}{\alpha\beta m}$. By (3.10),

$$\frac{\mathbb{P}_{\text{SAW}_n}(Z = z_1 | \zeta(\Gamma) = \sigma)}{\mathbb{P}_{\text{SAW}_n}(Z = z_2 | \zeta(\Gamma) = \sigma)} = (1 + o(1)) \exp\left(-\frac{1}{2\delta^5}(\log n)^{1/2+\varepsilon}\right) \geq n^{-\varepsilon'},$$

for n large enough. This proves (3.8).

We now turn to the deviations of Z from its mean (this corresponds to the first part of the lemma). From (3.9), $\mathbb{P}_{\text{SAW}_n}(Z = z | \zeta(\Gamma) = \sigma)$ is trivially unimodal in z with maximum at $z = 0$. For $|z| \geq \frac{\sqrt{n}(\log n)^{1/2+\varepsilon}}{\alpha\beta m}$, (3.10) implies the existence of constants $c_0, c_1 > 0$ depending only on δ such that, for n large enough,

$$(3.11) \quad \mathbb{P}_{\text{SAW}_n}(Z = z | \zeta(\Gamma) = \sigma) \leq \frac{\exp(-c_0(\log n)^{1+2\varepsilon})}{c_1\sqrt{n}} \leq n^{-C-1}.$$

Since T_I^1 takes no more than n values, (3.11) implies (3.7). \square

We are now in a position to prove Proposition 1.3.

Proof of Proposition 1.3. It suffices to prove the statement for n large. Let $n \in \mathbb{N}$ and $x \in \mathbb{Z}^d$.

Consider a shell σ with $x \in \gamma$ for some walk $\gamma \in \sigma$. Let S_1 be the slots of σ before x and let S_2 be the ones after. We will omit here the case where x is a point contained in one of the slots; this is purely a technical issue and does not change the proof in any significant way.

Consider walks $\gamma \in \text{SAW}_n$ with $\varsigma(\gamma) = \sigma$. Let t_σ be the number of type I patterns that such a walk needs to have in S_1 so that $\gamma_{\lfloor \frac{n}{2} \rfloor} = x$, if such a number exists and is contained in $[0, \min\{|S_1|, T_I\}]$. Denote \mathcal{S} the set of shells for which t_σ is well defined. Thus, if γ has midpoint x , then $\varsigma(\gamma) \in \mathcal{S}$. We may therefore write

$$(3.12) \quad \mathbb{P}_{\text{SAW}_n} \left(\Gamma_{\lfloor \frac{n}{2} \rfloor} = x \right) = \sum_{\sigma \in \mathcal{S}} \mathbb{P}_{\text{SAW}_n} (T_I^1 = t_\sigma, \varsigma(\Gamma) = \sigma).$$

There exist constants $\delta, c > 0$ such that

$$(3.13) \quad \begin{aligned} & \mathbb{P}_{\text{SAW}_n} \left(\Gamma[0, \frac{n}{4}] \text{ contains fewer than } \delta n \text{ type I patterns} \right) \\ & \leq \frac{c_{n/4} c_{3n/4}}{c_n} \mathbb{P}_{\text{SAW}_{n/4}} \left(\Gamma \text{ contains fewer than } \delta n \text{ type I patterns} \right) \\ & \leq e^{2c_{HW} \sqrt{n}} \mathbb{P}_{\text{SAW}_{n/4}} \left(\Gamma \text{ contains fewer than } \delta n \text{ type I patterns} \right) < e^{-cn}, \end{aligned}$$

where the second inequality comes from the Hammersley-Welsh bound (2.2), and the third from (3.1). The same holds for type II patterns, and for $\Gamma[\frac{3n}{4}, n]$ instead of $\Gamma[0, \frac{n}{4}]$. It follows that

$$(3.14) \quad \mathbb{P}_{\text{SAW}_n} \left(\min(|S_1|, |S_2|, T_I, T_{II}) < \delta n \right) < 4e^{-cn}.$$

For shells $\sigma \in \mathcal{S}$ such that $|S_1| \geq \delta n$ and $|S_2| \geq \delta n$, (3.10) gives

$$(3.15) \quad \mathbb{P}_{\text{SAW}_n} (T_I^1 = k \mid \varsigma(\Gamma) = \sigma) \leq Cn^{-1/2},$$

for some $C > 0$, any $k \in \mathbb{N}$ and n sufficiently large (i.e., larger than some value depending only on δ).

By applying (3.14) and (3.15) to (3.12), we obtain

$$\mathbb{P}_{\text{SAW}_n} \left(\Gamma_{\lfloor \frac{n}{2} \rfloor} = x \right) \leq 4e^{-cn} + Cn^{-1/2} \leq 2Cn^{-1/2},$$

for n sufficiently large. □

4. DELOCALIZATION OF THE ENDPOINT

This section is devoted to the proof of Theorem 1.1. Let us begin with some general definitions. A walk $\gamma \in \text{SAW}_n$ is called a *bridge* if

$$\langle \gamma_0 | e_1 \rangle < \langle \gamma_k | e_1 \rangle \leq \langle \gamma_n | e_1 \rangle, \quad \text{for } 0 < k \leq n.$$

Write SAB_n for the set of bridges of length n and $\mathbb{P}_{\text{SAB}_n}$ for the uniform measure on SAB_n .

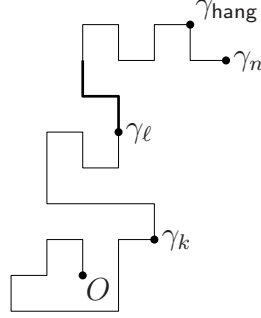

FIGURE 2. A walk γ with a renewal point γ_k , a z -renewal point γ_ℓ and hanging point γ_{hang} . The bold structure beyond the point γ_ℓ helps to ensure that ℓ is a z -renewal time. Both $\gamma[k, \ell]$ and $\gamma[k, \text{hang}]$ are bridges.

For $\gamma \in \text{SAW}_n$, an index $k \in [0, n]$ is a *renewal time* if $\langle \gamma_i | e_1 \rangle \leq \langle \gamma_k | e_1 \rangle$ for $0 \leq i < k$ and $\langle \gamma_i | e_1 \rangle > \langle \gamma_k | e_1 \rangle$ for $n \geq i > k$. Because it simplifies the proof of the next subsection in a substantial way, we introduce the notion of z -renewal. An index $k \in [0, n - 2]$ is a *z -renewal time* if

- $\langle \gamma_i | e_1 \rangle < \langle \gamma_{k+1} | e_1 \rangle$ for $0 \leq i < k + 1$,
- the edge $(\gamma_{k+1}, \gamma_{k+2})$ is not equal to e_1 or $-e_1$,
- $\langle \gamma_i | e_1 \rangle > \langle \gamma_{k+1} | e_1 \rangle$ for $n \geq i > k + 2$.

Note that a z -renewal time is necessarily a renewal time. Let \mathbf{zR}_γ denote the set of z -renewal times of γ . A (z -)renewal point is a point of the form γ_k where k is a (z -)renewal time.

4.1. The case of bridges. Let π_1 be the orthogonal projection from \mathbb{Z}^d onto the hyperplane $\mathbb{H} = \{x \in \mathbb{Z}^d : \langle x | e_1 \rangle = 0\}$, that is, for any $x \in \mathbb{Z}^d$,

$$\pi_1(x) = x - \langle x | e_1 \rangle e_1.$$

Our first step on the route to Theorem 1.1 is its analogue for bridges. Bridges are easier to handle due to their renewal and z -renewal points.

Proposition 4.1. *We have that $\lim_n \sup_{v \in \mathbb{H}} \mathbb{P}_{\text{SAB}_n}(\pi_1(\Gamma_n) = v) = 0$.*

This proposition follows from the next two statements. The first shows that typical bridges have many z -renewal times, and the second that the endpoint of a bridge with many z -renewal times is delocalized.

Proposition 4.2. *For any $M \in \mathbb{N}$, $\lim_n \mathbb{P}_{\text{SAB}_n}(|\mathbf{zR}_\Gamma| < M) = 0$.*

Proof. Fix $\varepsilon > 0$ and $M \in \mathbb{N}$ and let us show that, for n large enough, $\mathbb{P}_{\text{SAB}_n}(|zR_\Gamma| < M) < \varepsilon$.

Let SAB_n^M be the set of bridges of length n with strictly fewer than M z -renewal times. If $|\text{SAB}_n^M| < e^{-2c_{HW}\sqrt{n}}\mu_c^n$, we may use (2.2) to deduce that $\mathbb{P}_{\text{SAB}_n}(|zR_\Gamma| < M) < e^{-c_{HW}\sqrt{n}} \leq \varepsilon$, provided n is large enough.

From now on, assume

$$(4.1) \quad |\text{SAB}_n^M| \geq e^{-2c_{HW}\sqrt{n}}\mu_c^n.$$

Let $k = \lfloor n^{1/5} \rfloor$, and define the map

$$\Phi : \bigcup_{j=1}^k \text{SAB}_{n-2j}^M \times \text{SAB}_{2j-2} \longrightarrow \text{SAB}_n$$

that maps (γ_1, γ_2) to the concatenation of γ_1 , the walk whose consecutive edges are e_1 and e_2 , and γ_2 . Each $\gamma \in \text{SAB}_n$ has at most M pre-images under Φ , because, if Φ maps (γ_1, γ_2) to γ , then the endpoint of the copy of γ_1 in γ is one of the first M z -renewal points of γ . We deduce that

$$\sum_{j=1}^k |\text{SAB}_{n-2j}^M| \times |\text{SAB}_{2j-2}| \leq M|\text{SAB}_n|.$$

Lemma 3.3 applied with $A = \bigcup_{k \geq 0} \text{SAB}_k^M$, along with (4.1), provides the existence of an M -dependent constant $C > 0$ for which $|\text{SAB}_{n-2j}^M| \geq C\mu_c^{-2j}|\text{SAB}_n^M|$ for all $0 \leq j \leq k$. Thus,

$$\mathbb{P}_{\text{SAB}_n}(|zR_\Gamma| < M) = \frac{|\text{SAB}_n^M|}{|\text{SAB}_n|} \leq \frac{M}{C \sum_{j=1}^k |\text{SAB}_{2j-2}| \mu_c^{-2j}}.$$

However, it is a classical fact that the generating function for bridges diverges at criticality, i.e. $\sum_{j=1}^{\infty} |\text{SAB}_{2j}| \mu_c^{-2j} = \infty$. This is shown for instance in [16, Cor. 3.1.8]. As n tends to infinity, so does k , and therefore, for n sufficiently large, $\mathbb{P}_{\text{SAB}_n}(|zR_\Gamma| < M) < \varepsilon$. \square

Proposition 4.3. *For any $\varepsilon > 0$, there exists $M > 0$ such that, for any $n, h > 0$ and $x \in \mathbb{Z}^d$,*

$$\mathbb{P}_{\text{SAB}_n} \left(\Gamma_n = x \mid |zR_\Gamma| \geq M, \langle \Gamma_n | e_1 \rangle = h \right) \leq \varepsilon.$$

Proof. If k is a z -renewal time of a walk γ , and if the edge $(\gamma_{k+1}, \gamma_{k+2})$ is modified to take any one of the $2d - 2$ values $\pm e_2, \pm e_3, \dots$, the outcome remains self-avoiding and shares γ 's height. In light of this, the proof is trivial. \square

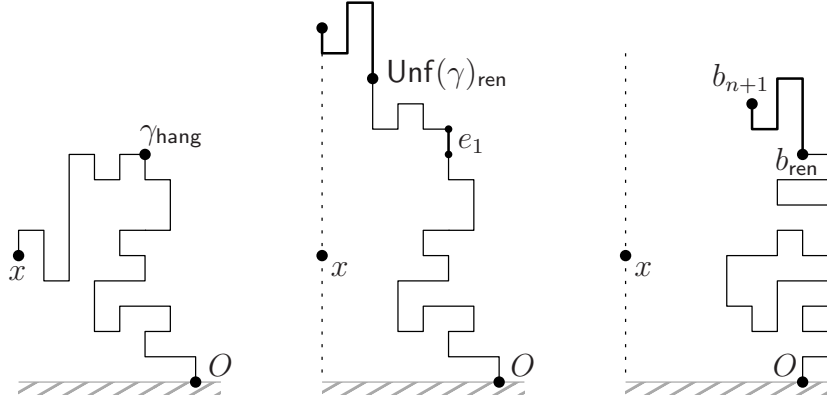

FIGURE 3. *Left:* A walk $\gamma \in \text{SAHSW}_n$ ending at x . *Middle:* The unfolding of γ , $\text{Unf}(\gamma)$, and its last renewal point $\text{Unf}(\gamma)_{\text{ren}}$. Notice the bold edge e_1 added between γ^1 and the reflection of γ^2 . *Right:* A walk $b \in \Phi(\gamma)$. Its last renewal point is b_{ren} ; $b[0, \text{ren}]$ is a bridge and $b[\text{ren}, n+1]$ is equal up to translation to $\text{Unf}(\gamma)[\text{ren}, n+1]$ (bold). The choice of $b[0, \text{ren}]$ may be such that $\pi_1(b_{n+1}) \neq \pi_1(x)$.

4.2. **The case of half-space walks.** Next, we prove delocalization for walks confined to a half-space. The set of *half-space walks* of length n is

$$\text{SAHSW}_n = \left\{ \gamma \in \text{SAW}_n : \langle \gamma_k | e_1 \rangle > 0 \text{ for all } 1 \leq k \leq n \right\}.$$

Let $\mathbb{P}_{\text{SAHSW}_n}$ denote the uniform measure on SAHSW_n .

Proposition 4.4. *We have that $\lim_n \sup_{x \in \mathbb{Z}^d} \mathbb{P}_{\text{SAHSW}_n}(\gamma_n = x) = 0$.*

Proof. Let $\varepsilon > 0$ and note that Proposition 4.1 ensures the existence of $H \in \mathbb{N}$ such that

$$(4.2) \quad \sup_{k \geq H, v \in \mathbb{H}} \mathbb{P}_{\text{SAB}_k}(\pi_1(\Gamma_k) = v) \leq \varepsilon.$$

First note that $\mathbb{P}_{\text{SAHSW}_n}(\langle \gamma_{\text{hang}} | e_1 \rangle \leq H)$ decays exponentially as $n \rightarrow \infty$. Indeed, the pattern theorem [14, Thm. 1] implies that, with probability exponentially close to one, a walk in SAHSW_n contains $H+1$ consecutive edges e_1 . We may therefore restrict our attention to walks going above height H .

Let $x \in \mathbb{Z}^d$ and define a multi-valued map $\Phi : \{\gamma \in \text{SAHSW}_n : \gamma_n = x\} \rightarrow \text{SAHSW}_{n+1}$ as follows. Let ren be the last renewal time of $\text{Unf}(\gamma)$ (recall the definition of Unf from Section 2.3) and let $\Phi(\gamma)$ be the set of all half-space walks which can be represented as the concatenation of some bridge of length ren and $\text{Unf}(\gamma)[\text{ren}, n]$. See Figure 3. Note that hang is a renewal time for

$\text{Unf}(\gamma)$ (this is due to the edge e_1 added between the two walks), hence ren is well defined and $\text{ren} \geq \text{hang}$. For any $\gamma \in \text{SAHSW}_n$, $|\Phi(\gamma)| = |\text{SAB}_{\text{ren}}|$.

In the other direction, let $b \in \text{SAHSW}_{n+1}$ and $\gamma \in \Phi^{-1}(b)$. The time ren of γ can be determined, since it is the last renewal time of b . As such, $\gamma[\text{ren}, n]$ is determined by b . Thus, $\gamma[0, \text{ren}]$ is a bridge with

$$\pi_1(\gamma_{\text{ren}}) = \pi_1(x + b_{\text{ren}} - b_{n+1}).$$

Furthermore, Unf is an injective function from $\{\chi \in \text{SAHSW}_n : \chi_n = x\}$ to SAHSW_{n+1} (indeed, the vertical coordinate of the hanging point of the original walk can be determined from knowing that the original walk ended at x). In conclusion,

$$|\Phi^{-1}(b)| \leq \left| \left\{ \chi \in \text{SAB}_{\text{ren}} : \pi_1(\chi_{\text{ren}}) = \pi_1(x + b_{\text{ren}} - b_{n+1}) \right\} \right|.$$

As mentioned before, we may suppose $\langle \gamma_{\text{hang}} | e_1 \rangle \geq H$, and therefore $\text{ren} \geq H$. The set $\Phi(\gamma)$ is independent of $\gamma \in \Phi^{-1}(b)$. Thus, for any choice of b , the contracting factor of Φ appearing in the multi-valued principle satisfies

$$\Lambda_\Phi(b) \leq \max_{k \geq H, v \in \mathbb{H}} \text{P}_{\text{SAB}_k}(\pi_1(\Gamma_k) = v) \leq \varepsilon.$$

The multi-valued map principle and the trivial inequality $|\text{SAHSW}_{n+1}| \leq 2d|\text{SAHSW}_n|$ yield $\text{P}_{\text{SAHSW}_n}(\gamma_n = x) \leq 2d\varepsilon$, and the proof is complete. \square

4.3. The case of walks (proof of Theorem 1.1). Fix $\varepsilon > 0$. Proposition 4.3 yields the existence of $M > 0$ such that, for any $n, h \geq 0$,

$$(4.3) \quad \sup_{x \in \mathbb{Z}^d} \text{P}_{\text{SAB}_n} \left(\Gamma_n = x \mid |z\mathbf{R}_\Gamma| \geq M, \langle \Gamma_n | e_1 \rangle = h \right) \leq \frac{\varepsilon}{2d}.$$

Fix such a value of M . Recall the notation $(\gamma^1, \gamma^2) = (\gamma[0, \text{hang}], \gamma[\text{hang}, n])$. We divide the proof in two cases, depending on whether Γ^1 possesses at least or fewer than M z -renewal times. The next two lemmas treat the two cases.

Lemma 4.5 (Many z -renewal times for Γ^1). *For n large enough,*

$$\sup_{x \in \mathbb{Z}^d} \text{P}_{\text{SAW}_n}(\Gamma_n = x \text{ and } |z\mathbf{R}_{\Gamma^1}| \geq M) \leq \varepsilon.$$

In the case where the first part contains few z -renewal times, we further demand that the hanging time be smaller than $n/2$.

Lemma 4.6 (Few z -renewal times for Γ^1). *For n large enough,*

$$\sup_{x \in \mathbb{Z}^d} \text{P}_{\text{SAW}_n}(\Gamma_n = x, \text{hang} \leq n/2 \text{ and } |z\mathbf{R}_{\Gamma^1}| < M) \leq \varepsilon.$$

Theorem 1.1 follows from the two lemmas because, as we now see, they imply that

$$\sup_{x \in \mathbb{Z}^d} \text{P}_{\text{SAW}_n}(\Gamma_n = x) \leq 4\varepsilon.$$

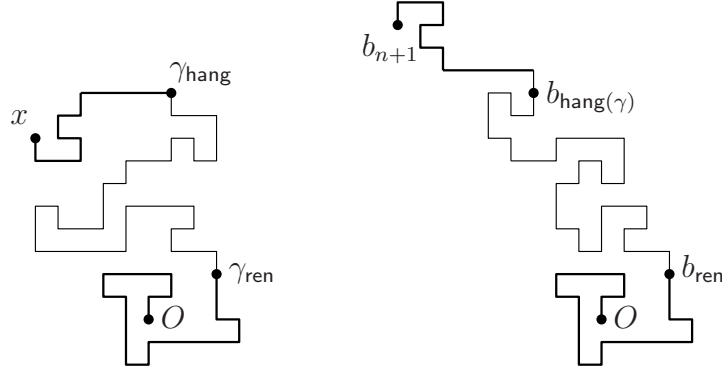

FIGURE 4. *Left:* A walk $\gamma \in E_M(x)$. *Right:* A walk $b \in \Phi(\gamma)$. The first and last parts of b (bold) are the same as those of γ (up to translation and reflection). Its middle part is a bridge with appropriate length and e_1 -displacement.

Indeed, the lemmas clearly yield

$$\sup_{x \in \mathbb{Z}^d} \mathbb{P}_{\text{SAW}_n}(\text{hang} \leq n/2 \text{ and } \Gamma_n = x) \leq 2\varepsilon,$$

for n large enough. The counterpart inequality with $\text{hang} \geq n/2$ may be obtained by reversing the walk's orientation (and translating it to start at the origin).

Thus the proof of Theorem 1.1 is reduced to demonstrating the two lemmas.

Proof of Lemma 4.5. For $n \in \mathbb{N}$, let $E_M(x)$ be the set of walks $\gamma \in \text{SAW}_n$ with $\gamma_n = x$ and $|\mathbf{zR}_{\gamma^1}| \geq M$. For such walks, let ren be the smallest renewal time of γ^1 (note that γ^1 has at least one renewal time, namely hang). Split γ^1 in two parts $\gamma^{11} = \gamma[0, \text{ren}]$, $\gamma^{12} = \gamma[\text{ren}, \text{hang}]$ and set $k = \text{hang} - \text{ren}$.

We define a multi-valued map $\Phi : E_M(x) \rightarrow \text{SAW}_{n+1}$ under which $\gamma \in E_M(x)$ is unfolded about hang and the sub-bridge γ^{12} is substituted by any bridge sharing γ^{12} 's length and e_1 -displacement (but not necessarily its displacement in other directions). More precisely, for $\gamma \in E_M(x)$, $\Phi(\gamma)$ is the set of walks $b \in \text{SAW}_{n+1}$ with the properties that

- $b[0, \text{ren}]$ is equal to γ^{11} ;
- $b[\text{ren}, \text{hang}]$ is the translate of a bridge of length k and e_1 -displacement

$$\langle \gamma_{\text{hang}} - \gamma_{\text{ren}} | e_1 \rangle,$$

and which has at least M z -renewal times;

- and $b[\text{hang}, n+1]$ is equal to $\text{Unf}(\gamma^2)$ (up to translation).

By construction such walks are indeed self-avoiding, so that $\Phi(\gamma)$ is well-defined. See Figure 4.

Let us now estimate the contracting factor Λ_Φ of Φ . For $\gamma \in E_M(x)$,

$$(4.4) \quad |\Phi(\gamma)| = \left| \left\{ \chi \in \text{SAB}_k : |\mathbf{zR}_\chi| \geq M \text{ and } \langle \chi_k | e_1 \rangle = \langle \gamma_{\text{hang}} - \gamma_{\text{ren}} | e_1 \rangle \right\} \right|.$$

For the number of pre-images, consider $\gamma \in \Phi^{-1}(b)$ for some $b \in \text{SAW}_{n+1}$ (note that $\Phi^{-1}(b)$ could be empty, in which case the conclusion is trivial). Since γ ends at x and the e_1 -displacement of the bridge which replaces γ^{12} in b is the same as that of γ^{12} , the e_1 -coordinate of the hanging point of γ is determined by b . Namely,

$$\langle \gamma_{\text{hang}} | e_1 \rangle = \langle b_{\text{hang}(\gamma)} | e_1 \rangle = \frac{\langle x | e_1 \rangle + \langle b_{n+1} | e_1 \rangle - 1}{2}.$$

But hang is a renewal time for b , hence the above determines hang . It follows that γ^2 is also determined by b (including its positioning which is given by the fact that $\gamma_n = x$). Moreover, since ren is the first renewal time of γ , it is also the first renewal time of $b[0, \text{hang}]$. Thus b determines γ^{11} as well. Finally, γ^{12} is a bridge with at least M z -renewals, between the determined points γ_{ren} and γ_{hang} . It follows that

$$(4.5) \quad |\Phi^{-1}(b)| \leq \left| \left\{ \chi \in \text{SAB}_k : |\mathbf{zR}_\chi| \geq M \text{ and } \chi_k = \gamma_{\text{hang}} - \gamma_{\text{ren}} \right\} \right|.$$

Since γ^{11} and γ^2 are determined by b , any $\gamma \in \Phi^{-1}(b)$ has the same number of images under Φ . Equations (4.4), (4.5) and the choice of M (see (4.3)) imply that $\Lambda_\Phi(b)$ is bounded by $\frac{\varepsilon}{2d}$ uniformly in γ , which immediately yields

$$|E_M(x)| \leq \frac{\varepsilon}{2d} |\text{SAW}_{n+1}| \leq \varepsilon |\text{SAW}_n|.$$

□

We finish with the easier proof of Lemma 4.6.

Proof of Lemma 4.6. Let $F_j(x)$ be the set of walks $\gamma \in \text{SAW}_n$ such that $\gamma_n = x$, $\text{hang} \leq n/2$ and $|\mathbf{zR}_{\gamma^1}| = j$.

We construct once again a multi-valued map Φ , this time from $F_j(x)$ to SAW_{n+3} . For $\gamma \in F_j(x)$, $\Phi(\gamma)$ comprises the walks formed by concatenating γ^1 , the walk whose consecutive edges are e_1 and e_2 , and any half-space walk of length $n - \text{hang} + 1$. See Figure 5.

The number of images through Φ satisfies $|\Phi(\gamma)| = |\text{SAHSW}_{n-\text{hang}+1}|$. To determine the number of pre-images, note that, if $b \in \Phi(\gamma)$, then $b_{\text{hang}(\gamma)}$ is the $(j+1)$ -st z -renewal point of b . Also, γ^2 is contained in the half-space $\{y \in \mathbb{Z}^d : \langle y | e_1 \rangle \leq \langle \gamma_{\text{hang}} | e_1 \rangle\}$ and ends at the point x . Such walks can easily be transformed into half-space walks of length $n - \text{hang} + 1$ by reflecting them and adding an edge e_1 at the beginning. Note that the endpoint of such a

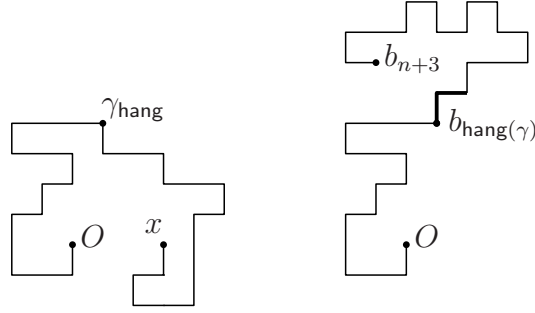

FIGURE 5. *Left:* A self-avoiding walk $\gamma \in F_j$. *Right:* A walk $b \in \Phi(\gamma)$. The point $b_{\text{hang}(\gamma)}$ is the $(j+1)$ -st z -renewal point of b ; it is followed by the edges e_1, e_2 (in bold), then by a half-space walk of length $n - \text{hang} + 1$.

walk is then determined by γ^1 and x . Using Proposition 4.4, we find that, for any $b \in \text{SAW}_{n+3}$, the contracting factor of Φ satisfies

$$\Lambda_\Phi(b) \leq \sup_{\substack{k \geq n/2+1 \\ z \in \mathbb{Z}^d}} \mathbf{P}_{\text{SAHSW}_k}(\Gamma_k = z) \leq \frac{\varepsilon}{(2d)^3 M},$$

provided that n is large enough. By the multi-valued map principle and $|\text{SAW}_{n+3}| \leq (2d)^3 |\text{SAW}_n|$, we obtain that $\mathbf{P}_{\text{SAW}_n}(F_j(x)) \leq \varepsilon/M$. By taking the union of the $F_j(x)$ over $j < M$, we obtain Lemma 4.6. \square

5. QUANTITATIVE DECAY FOR THE PROBABILITY OF ENDING AT x

We say that a walk $\gamma = \gamma[0, n]$ *closes* if γ_0 and γ_n are neighbors; a closing walk is one that closes. The fundamental step in our quantitative delocalization result, Theorem 1.2, is the following theorem.

Theorem 5.1. *For any $\varepsilon > 0$ and n large enough,*

$$\mathbf{P}_{\text{SAW}_n}(\Gamma \text{ closes}) \leq n^{-1/4+\varepsilon}.$$

The reduction of Theorem 1.2 to Theorem 5.1 is an exercise in local surgery whose details are a little technical. To permit our focus to remain at present on the central ideas needed for quantitative delocalization, we defer the argument to the final Section 5.2.

A little notation is in order as we prepare to prove Theorem 5.1.

Definition 5.2. *Two closing walks are said to be equivalent if the sequence of vertices visited by one is a cyclic shift of this sequence for the other. A (self-avoiding) polygon is an equivalence class for this equivalence relation. The length of a polygon is equal to the length of any member closing walk plus one. For $n \in \mathbb{N}$, let SAP_n be the set of polygons of length $n+1$.*

The following trivial lemma will play an essential role.

Lemma 5.3. *[Polygonal invariance] For $n \in \mathbb{N}$, let χ and χ' be two equivalent length- n closing walks. Then*

$$P_{\text{SAW}_n}(\Gamma \text{ is a translate of } \chi) = P_{\text{SAW}_n}(\Gamma \text{ is a translate of } \chi').$$

5.1. Deriving Theorem 5.1. We start by a non-rigorous overview. The actual proof is in Subsection 5.1.2.

5.1.1. An overview of the proof. The proof will proceed by contradiction. Suppose that the statement of Theorem 5.1 is false, and let n be a large integer such that $P_{\text{SAW}_n}(\Gamma \text{ closes}) \geq n^{-1/4+5\varepsilon}$. The factor 5ε in the exponent will be used as a margin of error which will decrease at several steps of the proof.

Fix an index $\ell_0 \in [\frac{n}{4}, \frac{3n}{4}]$ such that $P_{\text{SAW}_n}(\Gamma \text{ closes} \mid \text{hang} = \ell_0) \geq n^{-1/4+4\varepsilon}$. (The existence of such an index is proved in Lemma 5.4 and relies solely on polygonal invariance and the hypothesis that Theorem 5.1 is false.)

A walk ending at its hanging point will be called *good* if, when completed by $n - \ell_0$ steps in such a way that the hanging point is left unchanged, the resulting walk has probability at least $n^{-1/4+3\varepsilon}$ of closing. When thinking of walks as being built step by step, good walks should be thought of as first parts that leave a good chance for the walk to finally close. Since we assume that the walk closes with good probability, it is natural to expect that its first part is good with reasonable probability, and indeed one may prove (using polygonal invariance once again) that for our choice of ℓ_0 ,

$$P_{\text{SAW}_n}(\Gamma^1 \text{ is good} \mid \Gamma \text{ closes, hang} = \ell_0) \geq n^{-1/4+3\varepsilon}.$$

Here, the notation $\Gamma^1 = \Gamma[0, \text{hang}]$ for the walk's first part was introduced in Definition 2.2.

This estimate can be improved in the following way: one may change the value of the hanging time and prove that for $0 \leq k \leq \sqrt{n}$,

$$(5.1) \quad P_{\text{SAW}_n}(\Gamma^1 \text{ is good} \mid \Gamma \text{ closes, hang} = \ell_0 - 2k) \geq n^{-1/4+2\varepsilon}.$$

This part of the proof is heavily based on the resampling of patterns described in Lemma 3.5 and illustrated in Figure 6.

This study shows that, when considering closing walks as polygons, the $\ell_0 - 2k$ steps before the hanging point have reasonable probability of forming a good walk, for $k = 0, \dots, \sqrt{n}$. The correspondence between closing walks and polygons is essential here, as is the fact that the hanging point only depends on the polygon, not on the starting point of the closing walk.

Call a point whose index lies in $[\text{hang} - \ell_0, \text{hang}]$ of a closing walk *ticked* if the section of the walk between that point and the hanging point is good.

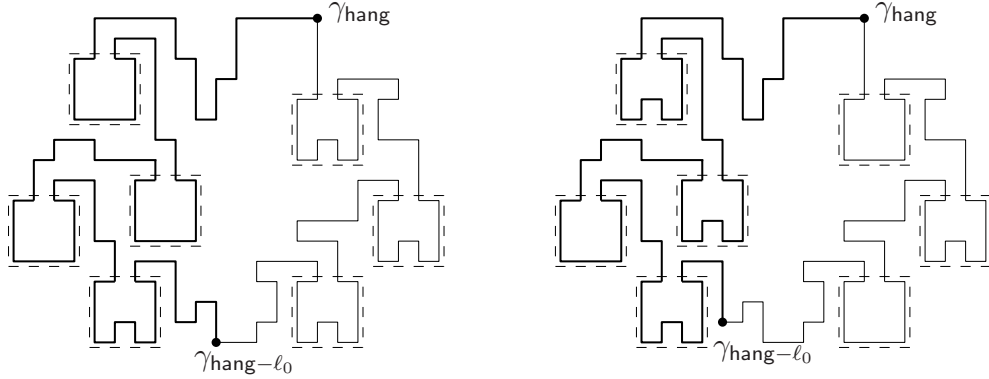

FIGURE 6. In a closing walk the ℓ_0 steps up to the hanging point form a good walk (bold). By exchanging type I and II patterns between the bold and regular part of the walk in a way that increases by order $n^{1/2}$ the number of type II patterns in the bold part, we may effectively shorten the good part by an amount of this order.

Since each of \sqrt{n} points have chance at least $n^{-1/4+2\varepsilon}$ to be ticked, the expected number of ticked points in a closing walk is at least $n^{1/4+2\varepsilon}$. It follows that, with probability greater than $n^{-1/4+\varepsilon}$, a closing walk has more than $n^{1/4+\varepsilon}$ ticked points.

We now reach the crucial part of the proof. Fix a walk with $\mathsf{T} \geq n^{1/4+\varepsilon}$ ticked points. By considering the portions of the walk between the ticked points and the hanging point, we obtain a family of good walks $\{\chi^i : i = 1, \dots, \mathsf{T}\}$, with $\chi^i \subset \chi^{i+1}$. See also Figure 7.

The existence of this family of good walks implies a very strong property of χ^{T} . Indeed, let Γ be a uniform self-avoiding walk of length $n - \ell_0$, starting at the (common) end-point z of the χ^i 's and with hanging point z (in words, it stays in the half-space “below” z). Note three properties. First, the events that Γ ends next to the starting point of χ^i , for $i = 1, \dots, \mathsf{T}$, are mutually exclusive (in fact, this is not quite true, as we will discuss in the proof). Second, the events that Γ avoids χ^i are decreasing with i (since χ^i is a portion of χ^{i+1}). Third, note that χ^i being good means that, when conditioning Γ to avoid χ^i , there is probability at least $n^{-1/4+3\varepsilon}$ that χ^i ends next to the starting point of χ^i . By using these three facts alongside $\mathsf{T} \geq n^{1/4+\varepsilon}$, the probability that Γ avoids χ^{T} can be proved to be stretched exponentially small, i.e. at most $e^{-cn^{4\varepsilon}}$ for some small constant $c > 0$.

Using an unfolding argument, this implies that, when conditioning on the ℓ_0 first steps of the walk to satisfy $\mathsf{T} \geq n^{1/4+\varepsilon}$ and resampling the end of the walk, the newly obtained walk has stretched exponentially small chance of

having ℓ_0 as its hanging time. It is therefore also stretched exponentially unlikely for a walk to have $n^{1/4+\varepsilon}$ ticked points in its first ℓ_0 steps and to have ℓ_0 as its hanging time. But by assumption, with probability $n^{-1/4+5\varepsilon}$, a walk is closing; moreover, by polygonal invariance, it has conditional probability $1/n$ to have ℓ_0 as its hanging time; and finally, as we have discussed, with a further conditional probability of at least $n^{-1/4+\varepsilon}$, its first ℓ_0 steps have $\mathsf{T} \geq n^{1/4+\varepsilon}$. Thus, the above event is both of probability at most stretched exponential and of probability at least $n^{-3/2+6\varepsilon}$, which of course is a contradiction if n is large enough.

5.1.2. *Proof of Theorem 5.1.* We now elaborate the heuristic argument presented in Subsection 5.1.1. As mentioned before, we will proceed by contradiction. Suppose that there exists $\varepsilon > 0$ such that

$$(5.2) \quad \mathsf{P}_{\text{SAW}_n}(\Gamma \text{ closes}) \geq n^{-\frac{1}{4}+5\varepsilon}$$

for an infinite number of values of $n \in \mathbb{N}$. (In particular $\varepsilon \leq 1/20$.)

Fix $n \geq \max\{2, 4^{1/\varepsilon} + 1\}$ for which (5.2) holds. Further bounds on n (depending only on ε) will be imposed. The next lemma and the bound $n > 4^{1/\varepsilon}$ permit us to fix an integer $\ell_0 \in [\frac{n}{4}, \frac{3n}{4}]$ such that

$$(5.3) \quad \mathsf{P}_{\text{SAW}_n}(\Gamma \text{ closes} \mid \text{hang} = \ell_0) \geq n^{-\frac{1}{4}+4\varepsilon}.$$

Lemma 5.4. *The number of $\ell \in \{0, \dots, n\}$ such that*

$$\mathsf{P}_{\text{SAW}_n}(\Gamma \text{ closes} \mid \text{hang} = \ell) \leq n^{-\frac{1}{4}+4\varepsilon}$$

is at most $2n^{1-\varepsilon}$.

Proof. By the polygonal invariance (Lemma 5.3), $\text{hang}(\Gamma)$ conditionally on Γ closing is uniform in $\{0, \dots, n\}$, so that, for each $\ell \in \{0, \dots, n\}$,

$$(5.4) \quad \mathsf{P}_{\text{SAW}_n}(\Gamma \text{ closes}, \text{hang} = \ell) = \frac{1}{n+1} \mathsf{P}_{\text{SAW}_n}(\Gamma \text{ closes}).$$

Hence, by (5.2),

$$\begin{aligned} \mathsf{P}_{\text{SAW}_n}(\Gamma \text{ closes} \mid \text{hang} = \ell) &= \frac{\mathsf{P}_{\text{SAW}_n}(\Gamma \text{ closes}, \text{hang} = \ell)}{\mathsf{P}_{\text{SAW}_n}(\text{hang} = \ell)} \\ &\geq \frac{n^{-\frac{1}{4}+5\varepsilon}}{n+1} \frac{1}{\mathsf{P}_{\text{SAW}_n}(\text{hang} = \ell)}, \end{aligned}$$

which in turn gives

$$n+1 = \sum_{\ell=0}^n (n+1) \mathsf{P}_{\text{SAW}_n}(\text{hang} = \ell) \geq \sum_{\ell=0}^n \frac{n^{-\frac{1}{4}+5\varepsilon}}{\mathsf{P}_{\text{SAW}_n}(\Gamma \text{ closes} \mid \text{hang} = \ell)}.$$

Since $n \geq 2$, the lemma follows. \square

Definition 5.5. A walk $\gamma \in \text{SAW}_\ell$ with $\text{hang}(\gamma) = \ell$ is said to be good if

$$\mathbb{P}_{\text{SAW}_{n+\ell-\ell_0}}(\Gamma \text{ closes} \mid \Gamma^1 = \gamma) \geq n^{-\frac{1}{4}+3\epsilon}.$$

Any translate of a good walk is also called good.

Thus, γ is good if, when completed with $n - \ell_0$ steps in such a way that the resulting walk has hanging time ℓ , the resulting walk has a reasonable chance of closing.

In the next lemma, we bound from below (still under the assumption that Theorem 1.2 is false) the probability of being good for the first part of a walk with hang close to ℓ_0 . We start with the case $\text{hang} = \ell_0$, then we resample patterns using Lemma 3.5 to change hang by an additive constant smaller than \sqrt{n} .

Lemma 5.6. For n large enough and any $0 \leq k \leq \sqrt{n}$,

$$(5.5) \quad \mathbb{P}_{\text{SAW}_n}(\Gamma^1 \text{ is good} \mid \Gamma \text{ closes}, \text{hang} = \ell_0 - 2k) \geq n^{-\frac{1}{4}+2\epsilon}.$$

Proof. We start with the case $k = 0$. First note that

$$\mathbb{E}_{\text{SAW}_n} \left[\mathbb{P}_{\text{SAW}_n}(\Gamma \text{ closes} \mid \Gamma^1) \mid |\Gamma^1| = \ell_0 \right] = \mathbb{P}_{\text{SAW}_n}(\Gamma \text{ closes} \mid \text{hang} = \ell_0) \geq n^{-\frac{1}{4}+4\epsilon}.$$

Since we may assume that $n \geq 2^{1/\epsilon}$,

$$(5.6) \quad \begin{aligned} & \mathbb{P}_{\text{SAW}_n}(\Gamma^1 \text{ is good} \mid \text{hang} = \ell_0) \\ &= \mathbb{P}_{\text{SAW}_n} \left(\mathbb{P}_{\text{SAW}_n}(\Gamma \text{ closes} \mid \Gamma^1) \geq n^{-\frac{1}{4}+3\epsilon} \mid |\Gamma^1| = \ell_0 \right) \geq n^{-\frac{1}{4}+3\epsilon}. \end{aligned}$$

But

$$(5.7) \quad \begin{aligned} & \frac{\mathbb{P}_{\text{SAW}_n}(\Gamma^1 \text{ is good} \mid \text{hang} = \ell_0; \Gamma \text{ closes})}{\mathbb{P}_{\text{SAW}_n}(\Gamma^1 \text{ is good} \mid \text{hang} = \ell_0)} \\ &= \frac{\mathbb{P}_{\text{SAW}_n}(\Gamma \text{ closes} \mid \Gamma^1 \text{ is good}; \text{hang} = \ell_0)}{\mathbb{P}_{\text{SAW}_n}(\Gamma \text{ closes} \mid \text{hang} = \ell_0)} \geq 1. \end{aligned}$$

The inequality is a direct consequence of the definition of a good walk. From (5.6) and (5.7), we deduce that

$$(5.8) \quad \mathbb{P}_{\text{SAW}_n}(\Gamma^1 \text{ is good} \mid \Gamma \text{ closes}; \text{hang} = \ell_0) \geq n^{-\frac{1}{4}+3\epsilon},$$

which is an improved version of (5.5) for $k = 0$.

Now we extend the result to general values of k . For this we will use Lemma 3.5.

First observe that, for a shell σ and a walk $\gamma \in \sigma$, the hanging point of γ is entirely determined by σ (beware of the fact that this is only true for the point, not the index).

For a walk γ , let S_1 denote the slots of $\zeta(\gamma)$ between the origin and γ_{hang} and S_2 those after γ_{hang} . (The type I and II patterns are such that γ_{hang}

cannot be a vertex belonging to a pattern of either type.) We say that γ is *balanced* if $\left| T_I^1(\Gamma) - \frac{T_I |S_1|}{|S_1| + |S_2|} \right| \leq \sqrt{n}(\log n)^{1/2+\varepsilon}$.

Fix $\delta, c > 0$ for which (3.13) holds. Let \mathcal{G} be the set of shells satisfying the assumptions of Lemma 3.5 and such that, if $\gamma \in \text{SAW}_n$ satisfies $\varsigma(\gamma) \in \mathcal{G}$, then γ^1 is good and γ closes. Call \mathcal{G}_{bal} the set of shells $\sigma \in \mathcal{G}$ such that any $\gamma \in \sigma$ with $\text{hang}(\gamma) = \ell_0$ is balanced.

Note that S_1 and S_2 depend on γ only via $\varsigma(\gamma)$. Also, whether γ^1 is good and whether γ is closing may each be determined from $\varsigma(\gamma)$ alone. Thus, $\varsigma(\gamma) \in \mathcal{G}$ as soon as $\varsigma(\gamma)$ satisfies the assumptions of Lemma 3.5, γ^1 is good and γ closes. Moreover, any two walks from SAW_n with the same shell and hanging time are either both balanced or both not balanced. Hence, for $\gamma \in \text{SAW}_n$ with $\text{hang} = \ell_0$ and $\varsigma(\gamma) \in \mathcal{G}$, the shell $\varsigma(\gamma)$ is in \mathcal{G}_{bal} as soon as γ is balanced.

It will be useful to note that, by (5.2), (5.8) and polygonal invariance,

$$\mathbb{P}_{\text{SAW}_n}(\Gamma^1 \text{ is good, } \Gamma \text{ closes and } \text{hang} = \ell_0) \geq n^{-\frac{3}{2}+7\varepsilon}.$$

By the choice of δ ,

$$\mathbb{P}_{\text{SAW}_n}(\varsigma(\Gamma) \notin \mathcal{G} \mid \Gamma^1 \text{ is good, } \Gamma \text{ closes and } \text{hang} = \ell_0) \leq 4e^{-cn}n^{\frac{3}{2}}.$$

By the first part of Lemma 3.5, for n large enough,

$$\mathbb{P}_{\text{SAW}_n}(\varsigma(\Gamma) \notin \mathcal{G}_{\text{bal}} \mid \varsigma(\Gamma) \in \mathcal{G}) \leq n^{-\frac{3}{2}}.$$

Using (5.8), the above inequalities yield

$$\mathbb{P}_{\text{SAW}_n}(\varsigma(\Gamma) \in \mathcal{G}_{\text{bal}} \mid \Gamma \text{ closes, } \text{hang} = \ell_0) \geq \frac{1}{2}n^{-\frac{1}{4}+3\varepsilon},$$

for n large enough.

Let $\sigma \in \mathcal{G}_{\text{bal}}$ and λ be the number of type I patterns needed in the first part of a walk $\gamma \in \sigma$ so that $\text{hang}(\gamma) = \ell_0$. By (3.8), for $0 \leq k \leq \sqrt{n}$ and n large enough,

$$\frac{\mathbb{P}_{\text{SAW}_n}(\text{hang} = \ell_0 - 2k \mid \varsigma = \sigma)}{\mathbb{P}_{\text{SAW}_n}(\text{hang} = \ell_0 \mid \varsigma = \sigma)} = \frac{\mathbb{P}_{\text{SAW}_n}(T_I^1(\Gamma) = \lambda + k \mid \varsigma = \sigma)}{\mathbb{P}_{\text{SAW}_n}(T_I^1(\Gamma) = \lambda \mid \varsigma = \sigma)} \geq 2n^{-\varepsilon}.$$

But

$$\begin{aligned} & \mathbb{P}_{\text{SAW}_n}(\Gamma^1 \text{ is good} \mid \Gamma \text{ closes, } \text{hang} = \ell_0 - 2k) \\ & \geq \sum_{\sigma \in \mathcal{G}_{\text{bal}}} \mathbb{P}_{\text{SAW}_n}(\varsigma(\Gamma) = \sigma \mid \Gamma \text{ closes, } \text{hang} = \ell_0 - 2k) \\ & = \sum_{\sigma \in \mathcal{G}_{\text{bal}}} \mathbb{P}_{\text{SAW}_n}(\text{hang} = \ell_0 - 2k \mid \varsigma(\Gamma) = \sigma) \frac{\mathbb{P}_{\text{SAW}_n}(\varsigma(\Gamma) = \sigma)}{\mathbb{P}_{\text{SAW}_n}(\Gamma \text{ closes, } \text{hang} = \ell_0 - 2k)} \end{aligned}$$

$$\begin{aligned}
&\geq 2n^{-\varepsilon} \sum_{\sigma \in \mathcal{G}_{\text{bal}}} \mathbb{P}_{\text{SAW}_n}(\text{hang} = \ell_0 \mid \zeta(\Gamma) = \sigma) \frac{\mathbb{P}_{\text{SAW}_n}(\zeta(\Gamma) = \sigma)}{\mathbb{P}_{\text{SAW}_n}(\Gamma \text{ closes, hang} = \ell_0)} \\
&= 2n^{-\varepsilon} \mathbb{P}_{\text{SAW}_n}(\zeta(\Gamma) \in \mathcal{G}_{\text{bal}} \mid \Gamma \text{ closes, hang} = \ell_0) \\
&\geq n^{-\frac{1}{4}+2\varepsilon}.
\end{aligned}$$

Here, we used polygonal invariance (Lemma 5.3) to assert that

$$\mathbb{P}_{\text{SAW}_n}(\Gamma \text{ closes, hang} = \ell_0 - 2k) = \mathbb{P}_{\text{SAW}_n}(\Gamma \text{ closes, hang} = \ell_0).$$

□

Definition 5.7. For a closing walk $\gamma \in \text{SAW}_n$, an index ℓ is said to be ticked if $\gamma[\text{hang} - \ell, \text{hang}]$ is good.

In this definition, closing walks are viewed as polygons and we use the modulo $n + 1$ notation for their indices. Thus $\gamma[\text{hang} - \ell, \text{hang}]$ may contain the edge (γ_n, γ_0) . Note that the hanging point and the ticked indices of a closing walk only depend on the corresponding polygon.

Let $\mathbb{T} = \mathbb{T}(\gamma)$ be the number of ticked indices in $\{\ell_0 - 2k, 0 \leq k \leq \sqrt{n}\}$. The next lemma shows that the probability of having many ticked points is not too small.

Lemma 5.8. For n large enough,

$$\mathbb{P}_{\text{SAW}_n}(\mathbb{T}(\Gamma) \geq n^{\frac{1}{4}+\varepsilon} \mid \Gamma \text{ closes}) \geq n^{-\frac{1}{4}+\varepsilon}.$$

Proof. Consider n large enough so that Lemma 5.6 holds. For $0 \leq k \leq \sqrt{n}$,

$$\begin{aligned}
&\mathbb{P}_{\text{SAW}_n}(\ell_0 - 2k \text{ is ticked} \mid \Gamma \text{ closes}) \\
&= \mathbb{P}_{\text{SAW}_n}(\Gamma^1 \text{ is good} \mid \Gamma \text{ closes, hang} = \ell_0 - 2k) \geq n^{-\frac{1}{4}+2\varepsilon},
\end{aligned}$$

where the equality is due to polygonal invariance (Lemma 5.3) and the inequality to Lemma 5.6. It follows that

$$\mathbb{E}_{\text{SAW}_n}[\mathbb{T}(\Gamma) \mid \Gamma \text{ closes}] = \sum_{k=0}^{\sqrt{n}} \mathbb{P}_{\text{SAW}_n}(\ell_0 - 2k \text{ is ticked} \mid \Gamma \text{ closes}) \geq n^{\frac{1}{4}+2\varepsilon}.$$

Since \mathbb{T} is bounded by $1 + \sqrt{n}$ and $n \geq 4^{1/\varepsilon}$, we find that

$$\mathbb{P}_{\text{SAW}_n}(\mathbb{T}(\Gamma) \geq n^{-\frac{1}{4}+\varepsilon} \sqrt{n} \mid \Gamma \text{ closes}) \geq n^{-\frac{1}{4}+\varepsilon}.$$

□

The next lemma shows that a portion of walk with many ticked indices, ending at some site z , is very unlikely to be the beginning of a self-avoiding walk whose hanging point is z .

Lemma 5.9. *For a closing walk $\chi \in \text{SAW}_n$ with $\mathsf{T}(\chi) \geq n^{\frac{1}{4}+\varepsilon}$,*

$$(5.9) \quad \mathbb{P}_{\text{SAW}_n} \left(\text{hang}(\Gamma) = \ell_0 \mid \Gamma[0, \ell_0] = \chi[\text{hang} - \ell_0, \text{hang}] \right) \leq e^{-n^\varepsilon}.$$

Proof. Let $\chi \in \text{SAW}_n$ be a closing walk with $\mathsf{T}(\chi) \geq n^{\frac{1}{4}+\varepsilon}$ and assume without loss of generality that $\text{hang}(\chi) = n$.

For the purpose of this proof only, let W be the set of walks γ of length $n - \ell_0$, originating at χ_n , with $\text{hang}(\gamma) = 0$. Let P denote the uniform measure on the set W . When working with P , Γ denotes a random variable distributed according to P . In particular, Γ is contained in the half-space below χ_n .

We now extend the notion of closing walk by saying that γ' *closes* γ if $\gamma|_{\gamma'} = \gamma'_0$ and $\gamma'_{|\gamma'}$ is adjacent to γ_0 . We say that γ' *avoids* γ if $\gamma' \cap \gamma = \{\gamma'_0\}$.

Let $t_1 < \dots < t_{\mathsf{T}}$ be the ticked indices of χ contained in $\{\ell_0 - 2k, 0 \leq k \leq \sqrt{n}\}$. Consider the walks $\chi^j = \chi[n - j, n]$ for $0 \leq j \leq n$. They all end at χ_n and $\chi^j \subsetneq \chi^{j+1}$. For $1 \leq i \leq \mathsf{T}$, define

$$A_i = \{\Gamma \text{ avoids } \chi^{t_i}\} \quad \text{and} \quad C_i = \{\Gamma \text{ closes } \chi^{t_i}\}.$$

Also, let $A = \{\gamma \in W : \gamma \text{ avoids } \chi^{\ell_0}\}$.

Since χ^{t_i} is good,

$$(5.10) \quad P(\Gamma \text{ closes } \chi^{t_i} \mid \Gamma \text{ avoids } \chi^{t_i}) = P(C_i \mid A_i) \geq n^{-\frac{1}{4}+3\varepsilon}.$$

Write $k = \lceil 4dn^{\frac{1}{4}-3\varepsilon} \rceil$ and suppose that $k \leq \mathsf{T}$. Any realization $\Gamma \in W$ is in at most $2d$ events C_i . Hence, by (5.10) and the fact that the A_j are decreasing,

$$2d \geq \sum_{i=1}^k P(C_i) \geq \sum_{i=1}^k P(C_i \mid A_i) P(A_k) \geq 4dP(A_k).$$

Therefore, $P(A_k) \leq \frac{1}{2}$. If the procedure is repeated between $k+1$ and $2k$, one obtains

$$2d \geq \sum_{i=k+1}^{2k} P(C_i \mid A_k) \geq \sum_{i=k+1}^{2k} P(C_i \mid A_i) P(A_{2k} \mid A_k) \geq 4dP(A_{2k} \mid A_k),$$

and thus $P(A_{2k} \mid A_k) \leq 1/2$. Since $A_{2k} \subset A_k$, we find

$$P(A_{2k}) = P(A_k)P(A_{2k} \mid A_k) \leq \frac{1}{4}.$$

This procedure may be repeated $\lfloor \frac{\mathsf{T}}{k} \rfloor$ times. Since $\mathsf{T} \geq n^{\frac{1}{4}+\varepsilon}$, we obtain

$$\frac{|A|}{|W|} = P(\Gamma \text{ avoids } \chi^{\ell_0}) \leq P(A_{\mathsf{T}}) \leq 2^{-\lfloor \frac{\mathsf{T}}{k} \rfloor} \leq 2^{-\frac{n^{4\varepsilon}}{2(4d+1)}},$$

for n large enough and $\varepsilon \leq 1/12$, which can be harmlessly assumed.

Let us now express the probability in (5.9) in terms of the ratio $|A|/|W|$. The set A contains all the possible continuations γ of χ^{ℓ_0} for which $\chi^{\ell_0} \circ \gamma$ is a

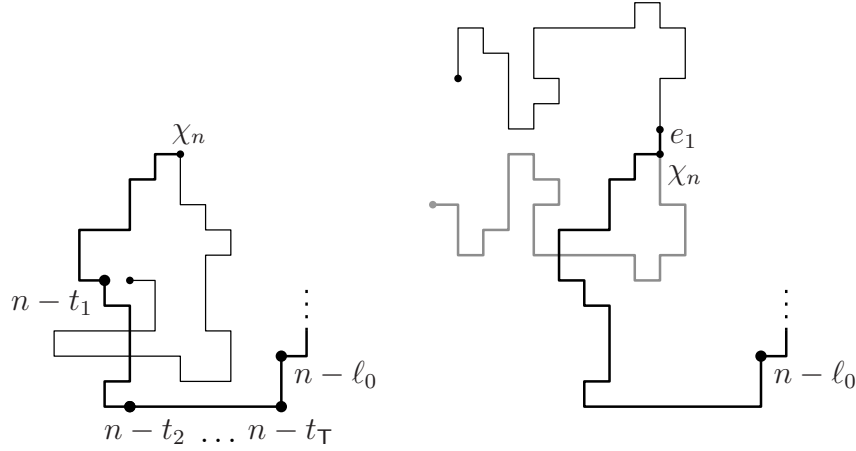

FIGURE 7. *Left:* The final portion of χ in bold, and a walk contained in C_1 and in A_1 but not in A_2 . *Right:* A walk $\gamma \in W \setminus A$ (gray) may be reflected and added to χ^{ℓ_0} (black) to create a walk starting with χ^{ℓ_0} , with hanging point different from χ_n . When concatenating $\mathcal{R}_{\chi_n}(\gamma)$ to χ^{ℓ_0} , an extra vertical edge is added in to ensure non-intersection, and the last edge is deleted to preserve length n .

self-avoiding walk of length n with $\text{hang} = \ell_0$. On the other hand, for $\gamma \in W$, the walk obtained by concatenating to χ^{ℓ_0} an edge e_1 followed by $\mathcal{R}_{\chi_n}(\gamma)$ is a self-avoiding walk of length $n+1$ with $\text{hang} > \ell_0$. By deleting the last edge of such walks, we obtain at least $|W|/2d$ walks of length n , starting with χ^{ℓ_0} and having $\text{hang} \neq \ell_0$. See Figure 7. Thus,

$$P_{\text{SAW}_n}(\text{hang}(\Gamma) = \ell_0 \mid \Gamma[0, \ell_0] = \chi^{\ell_0}) \leq \frac{2d|A|}{|W|} \leq 2d2^{-\frac{n^{4\epsilon}}{2(4d+1)}} \leq e^{-n^\epsilon}$$

for n large enough. This proves (5.9). \square

We are now ready to conclude the proof of Theorem 5.1. A walk $\chi[\text{hang} - \ell_0, \text{hang}]$ is *untouchable* if (5.9) is satisfied. By Lemmas 5.8, 5.9 and polygonal invariance,

$$P_{\text{SAW}_n}(\Gamma^1 \text{ is untouchable} \mid \Gamma \text{ closes, } \text{hang} = \ell_0) \geq n^{-\frac{1}{4} + \epsilon}.$$

Hence

$$\begin{aligned} \frac{n^{-\frac{1}{4} + 5\epsilon}}{n+1} &\leq P_{\text{SAW}_n}(\Gamma \text{ closes, } \text{hang} = \ell_0) \\ &\leq \frac{P_{\text{SAW}_n}(\Gamma \text{ closes, } \text{hang} = \ell_0)}{P_{\text{SAW}_n}(\Gamma[0, \ell_0] \text{ is untouchable})} \end{aligned}$$

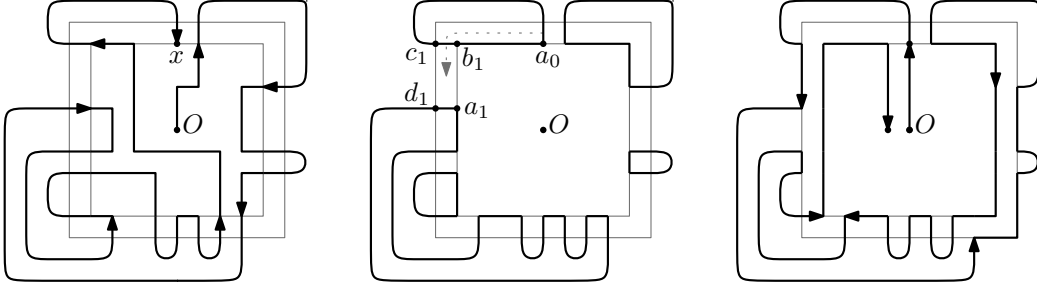

FIGURE 8. *Left:* A self-avoiding walk γ in $\text{SAW}_n(x)$. *Middle:* The polygons p_0, \dots, p_ℓ forming $E \cup F$. *Right:* The set G is obtained from $E \cup F$ by adding the edges between b_i and a_i and those between c_i and d_i and removing (a_i, d_i) and (b_i, c_i) .

$$\begin{aligned}
& \times \frac{\mathbb{P}_{\text{SAW}_n}(\Gamma[0, \ell_0] \text{ is untouchable, hang} = \ell_0)}{\mathbb{P}_{\text{SAW}_n}(\Gamma[0, \ell_0] \text{ is untouchable, } \Gamma \text{ closes, hang} = \ell_0)} \\
& = \frac{\mathbb{P}_{\text{SAW}_n}(\text{hang} = \ell_0 \mid \Gamma[0, \ell_0] \text{ is untouchable})}{\mathbb{P}_{\text{SAW}_n}(\Gamma[0, \ell_0] \text{ is untouchable} \mid \Gamma \text{ closes, hang} = \ell_0)} \\
& \leq e^{-n^\varepsilon} n^{\frac{1}{4}-\varepsilon}.
\end{aligned}$$

This is a contradiction for n large enough, and the proof of Theorem 5.1 is complete. \square

5.2. From Theorem 5.1 to Theorem 1.2. Deducing Theorem 1.2 from Theorem 5.1 is based on a simple surgery argument.

First some notation. Fix $x \in \mathbb{Z}^d$ and denote $m = \|x\|_\infty = \max\{|x_i| : 1 \leq i \leq d\}$. For $k \in \mathbb{N}$, let $\Lambda_k = [-k, k]^d \cap \mathbb{Z}^d$ and $E(\Lambda_k)$ be the set of edges (u, v) with $u, v \in \Lambda_k$. Fix $n \in \mathbb{N}$ and let $\text{SAW}_n(x) = \{\gamma \in \text{SAW}_n : \gamma_n = x\}$.

We will construct a map

$$\Phi : \text{SAW}_n(x) \rightarrow \bigcup_{k: |k-n| \leq |E(\Lambda_{m+1})|} \{\gamma \in \text{SAW}_k : \gamma \text{ closes}\},$$

with the property that, for any $\gamma \in \text{SAW}$, $|\Phi^{-1}(\gamma)| \leq 2^{|E(\Lambda_{m+1})|}$. By Theorem 5.1, for $\varepsilon > 0$, assuming n is large enough, the image of Φ has at most $(2^{|E(\Lambda_{m+1})|} + 1)n^{-1/4+\varepsilon}|\text{SAW}_n|$ elements. Theorem 1.2 follows readily.

For clarity we start with the construction of Φ for $d = 2$. The case $d \geq 3$ will be briefly explained later. Figure 8 may help to follow the proof.

Let $\gamma \in \text{SAW}_n(x)$ and E be the set of edges visited by γ which are not contained in Λ_m . The set E may be partitioned into walks χ_1, \dots, χ_k , each of them having both endpoints on $\partial\Lambda_m$. Let y_1, \dots, y_{2k} be these endpoints, taken in anticlockwise order, starting at x .

Let F be the set of edges of $\partial\Lambda_m$ between y_{2i-1} and y_{2i} for $i = 1, \dots, k$. Then $E \cup F$ may be partitioned into disjoint self-avoiding polygons. We identify $E \cup F$ with the union of the edges it contains.

Let us go around Λ_m in anticlockwise order, starting at x . Let a_0 be the first vertex in $E \cup F$, and a_{i+1} be the first such vertex, not connected to a_0, \dots, a_i in $E \cup F$. Index the polygons of $E \cup F$ as p_0, \dots, p_ℓ , such that $a_i \in p_i$. Write b_i for the last vertex of $E \cup F$ visited before a_i , c_i for the neighbour of b_i in $(E \cup F) \cap \partial\Lambda_{m+1}$ and d_i for the neighbour of a_i in $(E \cup F) \cap \partial\Lambda_{m+1}$. See Figure 8, middle diagram.

We obtain the set of edges G from $E \cup F$ by removing the edges (a_i, d_i) and (b_i, c_i) and adding the edges of $\partial\Lambda_m$ between b_i and a_i and those of $\partial\Lambda_{m+1}$ between c_i and d_i , for $i = 1, \dots, \ell$. Then the edges in G form a self-avoiding polygon.

Finally, remove an edge from $G \cap \partial\Lambda_m$, and connect its endpoints to 0 and to one of its neighbours, inside Λ_m . The closing walk thus obtained is denoted by $\Phi(\gamma)$. See Figure 8, right diagram.

Note that $\Phi(\gamma)$ is identical to γ outside Λ_{m+1} . Thus there are at most $2^{|E(\Lambda_{m+1})|}$ pre-images for any given image. Also $\Phi(\gamma)$ has between $n - |E(\Lambda_{m+1})|$ and $n + |E(\Lambda_{m+1})|$ edges.

For $d \geq 3$ a similar construction may be performed. We sketch it next.

Let ζ be a self-avoiding polygon on $\partial\Lambda_m$ visiting all vertices of $\partial\Lambda_m$. Let $\tilde{\zeta}$ be a self-avoiding polygon on $\partial\Lambda_{m+1}$ with the property that, if $u, v \in \partial\Lambda_{m+1}$ with $u \sim \zeta_i$, $v \sim \zeta_j$ and $i < j$, then $\tilde{\zeta}$ visits u before v . (Note that, for any $u \in \partial\Lambda_{m+1}$, there exists at most one i such that $u \sim \zeta_i$.) The existence of ζ and $\tilde{\zeta}$ may be proved by recurrence on d . We do not give additional details on this technical issue.

As for $d = 2$, we consider the set E of edges of γ not contained in Λ_m , and partition it into walks χ_1, \dots, χ_k , with endpoints y_1, \dots, y_{2k} on $\partial\Lambda_m$, in the order given by ζ .

By adding to E the set F of edges of ζ between y_{2i-1} and y_{2i} for $i = 1, \dots, k$, we create a family of disjoint self-avoiding polygons p_0, \dots, p_ℓ . The points a_i , b_i , c_i and d_i are defined as before, with the anticlockwise order replaced by the order given by ζ .

In order to unite p_0, \dots, p_ℓ into a single polygon, we remove from $E \cup F$ the edges (a_i, d_i) and (b_i, c_i) and add the portions of ζ between b_i and a_i and those of $\tilde{\zeta}$ between c_i and d_i , for $i = 1, \dots, \ell$. Thus we obtain a self-avoiding polygon G , which we modify as for $d = 2$ to create a closing walk starting at the origin.

REFERENCES

- [1] R. Bauerschmidt, H. Duminil-Copin, J. Goodman, and G. Slade. Lectures on self-avoiding walks. In D. Ellwood, C. Newman, V. Sidoravicius, and W. Werner, editors, *Lecture notes, in Probability and Statistical Physics in Two and More Dimensions*. CMI/AMS – Clay Mathematics Institute Proceedings, 2011.
- [2] N. Beaton, M. Bousquet-Mélou, H. Duminil-Copin, J. de Gier, and A.J. Guttmann. The critical fugacity for surface adsorption of self-avoiding walks on the honeycomb lattice is $1 + \sqrt{2}$. arXiv:arXiv:1109.0358, 2012.
- [3] D. C. Brydges, J.Z. Imbrie, and G. Slade. Functional integral representations for self-avoiding walk. *Probab. Surv.*, 6:34–61, 2009.
- [4] David Brydges and Gordon Slade. Renormalisation group analysis of weakly self-avoiding walk in dimensions four and higher. In *Proceedings of the International Congress of Mathematicians. Volume IV*, pages 2232–2257, New Delhi, 2010. Hindustan Book Agency.
- [5] H. Duminil-Copin and A. Hammond. Self-avoiding walk is sub-ballistic. *Comm. Math. Phys.*, to appear., 2012.
- [6] H. Duminil-Copin and S. Smirnov. The connective constant of the honeycomb lattice equals $\sqrt{2 + \sqrt{2}}$. *Ann. of Math.*, 175(3):1653–1665, 2012.
- [7] Bertrand Duplantier. Fractals in two dimensions and conformal invariance. *Phys. D*, 38(1-3):71–87, 1989. Fractals in physics (Vence, 1989).
- [8] Bertrand Duplantier. Renormalization and conformal invariance for polymers. In *Fundamental problems in statistical mechanics VII (Altenberg, 1989)*, pages 171–223. North-Holland, Amsterdam, 1990.
- [9] P. Flory. *Principles of Polymer Chemistry*. Cornell University Press, 1953.
- [10] A. Glazman. Connective constant for a weighted self-avoiding walk on \mathbb{Z}^2 . Preprint, 2013.
- [11] J. M. Hammersley and D. J. A. Welsh. Further results on the rate of convergence to the connective constant of the hypercubical lattice. *Quart. J. Math. Oxford Ser. (2)*, 13:108–110, 1962.
- [12] T. Hara and G. Slade. Critical behaviour of self-avoiding walk in five or more dimensions. *Bull. Amer. Math. Soc. (N.S.)*, 25(2):417–423, 1991.
- [13] T. Hara and G. Slade. Self-avoiding walk in five or more dimensions. I. The critical behaviour. *Comm. Math. Phys.*, 147(1):101–136, 1992.
- [14] Harry Kesten. On the number of self-avoiding walks. *J. Mathematical Phys.*, 4:960–969, 1963.
- [15] G. F. Lawler, O. Schramm, and W. Werner. On the scaling limit of planar self-avoiding walk. In *Fractal geometry and applications: a jubilee of Benoît Mandelbrot, Part 2*, volume 72 of *Proc. Sympos. Pure Math.*, pages 339–364. Amer. Math. Soc., Providence, RI, 2004.
- [16] N. Madras and G. Slade. *The self-avoiding walk*. Probability and its Applications. Birkhäuser Boston Inc., Boston, MA, 1993.
- [17] Neal Madras. A lower bound for the end-to-end distance of self-avoiding walk. Published electronically in *Canadian Mathematical Bulletin*, doi:10.4153/CMB-2012-022-6, 2012.
- [18] B. Nienhuis. Exact critical point and critical exponents of $O(n)$ models in two dimensions. *Phys. Rev. Lett.*, 49:1062–1065, 1982.
- [19] B. Nienhuis. Coulomb gas description of 2D critical behaviour. *J. Statist. Phys.*, 34:731–761, 1984.

- [20] W.J.C. Orr. Statistical treatment of polymer solutions at infinite dilution. *Transactions of the Faraday Society*, 43:12–27, 1947.

DEPARTMENT OF STATISTICS, UNIVERSITY OF OXFORD, 1 SOUTH PARKS ROAD, OXFORD, OX1 3TG, U.K.

DÉPARTEMENT DE MATHÉMATIQUES, UNIVERSITÉ DE GENÈVE, 2–4 RUE DU LIÈVRE, GENÈVE, SWITZERLAND.

ST. PETERSBURG DEPARTMENT OF STEKLOV MATHEMATICAL INSTITUTE (PDMI RAS). FONTANKA 27, 191023 ST. PETERSBURG, RUSSIA

E-mail address: `duminil.copin@unige.ch`, `alexander.glazman@unige.ch`,
`hammond@stats.ox.ac.uk`, `ioan.manolescu@unige.ch`